

Pneumatic Products

Synonymous with quality, high performance and safety

PNEUMATICS



With close to 60 years in business CEJN can be found in every corner of the world and we're proud to say we're still "made in Sweden".



THIS IS WHO WE ARE!

QUICK CONNECT COUPLINGS MADE IN SWEDEN SINCE 1955

PROFESSIONAL, HIGH QUALITY AND INNOVATIVE PRODUCTS have been produced by us at CEJN since our first patented top of the line coupling was released in 1955. CEJN is an independent global niche company that has expanded worldwide, and we are proud that we have been able to maintain our roots in the heart of Sweden.

We are committed to maintaining our high standards of responsibility to our customers, employees and the environment. "Made in Sweden" is for us a seal of high industrial quality. Add "by CEJN" and you get the assurance of quality and superior performance.

Content

YOUR SAFETY IS OUR PRIORITY	04
SAVE YOUR MONEY	06
NIPPLE PROFILE	08
COUPLINGS & NIPPLES	09
MULTI-LINK SYSTEM	33
STREAM-LINE HOSE	35
HOSE KITS	41
AIR & FLUID GUNS	48
HOSE AND CABLE REELS	53
FRL PRODUCTS	57
ACCESSORIES	66
FACTS AND FIGURES	72

NOTE! Not all connections/versions in the catalogue are standard stock items at the factory. The local CEJN companies may carry different versions as standard stock items. Check with an authorized CEJN distributor for availability and prices. Some part numbers are subject to minimum order quantities.





NO MORE NEED TO CHOOSE
BETWEEN PERFORMANCE & SAFETY

YOUR SAFETY IS OUR PRIORITY!

Compressed air is a powerful media and the first and foremost concern must be safety in our workplace! Safety has been one of the top priorities at CEJN for years, when designing and producing high quality products for customers around the world. Our latest addition to the CEJN pneumatic family is the eSafe coupling which has been given the best features on the market with Vented Safety function. With eSafe and our compliant products you can rest assured that you will have the most effective and safe workplace possible.



eSafe™



CEJN eSafe - Anti-whip function



Standard - No anti-whip function

PNEUMATIC PRODUCTS THAT PROMOTE A SAFE WORKPLACE

CEJN BELIEVES STRONGLY IN WORKPLACE SAFETY and our pneumatic line includes several products that are specially designed to protect individuals from harm by guarding against workplace injuries. Industry standards such as International Organization For Standardization (ISO) and U.S. Department of Labor Occupational Safety & Health Administration (OSHA) are utilized as the fundamental framework for the development of CEJN pneumatic products with safety-related designs. Each safety-related product is manufactured with the intent to comply with applicable federal regulations regarding safety requirements in order to achieve CEJN's strategic objective: providing our customers with pneumatic products that promote a safe workplace.

CEJN SAFETY RANGE

- Vented safety couplings with anti-hose whip feature**
 Vents the pressure before disconnecting, reducing the noise level when disconnecting and eliminating the risk of operator injuries caused by hose-whip. Available in several series, as well as Soft-Line and Multi-Link versions
- Couplings with added locking feature**
 Require the operator to deliberately disengage the nipple from the coupling, preventing unintentional disconnection
- Hose kits**
 Include vented safety couplings installed on spiral or straight braided hose in a complete safety package
- Blowgun with regulator**
 Reduces output pressure to a safe level (2 bar/30 PSI) when dead-ended
- Blowgun with Star-Tip**
 Reduces noise levels down to 85 dB(A) or less; diverts air when dead-ended, preventing pressures exceeding 2 bar (30 PSI)
- Hose and cable reels**
 Keep hose and cable off the floor, where they can cause personnel to trip and fall



CEJN Safety

Look for the CEJN Safety symbol to find your safety product



SAVE YOUR MONEY

WITH HIGH FLOW & LOW PRESSURE DROP



Is your compressed air system optimized? CEJN takes the question of overall compressed air economy seriously and has developed a profound expertise in the field of flow, energy saving and waste elimination, which is mirrored in our products. Using high quality CEJN products will make your production more efficient. Let us show you how you can save money!

IN ORDER TO GET A GOOD COMPRESSED AIR ECONOMY you need to know what air flow your tools need and the pressure drop all the components in the system cause. Products of low quality have a tendency to leak, restrict the flow and reduce the pressure in the system. With decreased flow you get less tool power and longer working cycles leading to higher costs. This is a waste of resources!

CEJN FOCUSES ON GIVING THE PRODUCTS A HIGH FLOW AND LOW PRESSURE DROP to reduce your energy consumption, increase your efficiency and prolong the life cycle costs with high quality products. Add CEJN Stream-line hoses, hose reels and FRL-systems to our renowned couplings and blowguns and you get a complete optimal system while saving money.

HOW OPTIMIZED IS YOUR SYSTEM?

1 AVOID PRESSURE DROP!

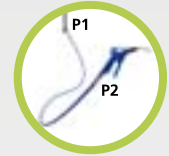

PRESSURE DROP is defined as the difference in pressure between two points of a compressed air system. The route from the wall outlet to the tool contains a number of pipes, fittings, hoses, surface roughness and other physical properties and all these are factors that cause resistance to the flow. In order to maintain a high flow and low pressure drop you need to invest in products minimizing energy loss.

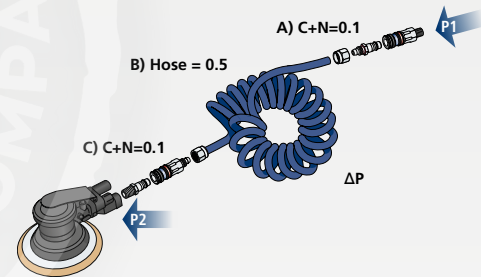

P1 outlet pressure from wall outlet
P2 inlet pressure to tool
ΔP difference between inlet and outlet
A) pressure drop in C+N
B) pressure drop hoses
C) pressure drop in C+N

DON'T WASTE TIME WAITING! To illustrate the benefits of eSafe, we put a Series 320 eSafe coupling to the test and compared it to a competitive brand coupling, letting all the other factors stay the same.

Watch the movie Performance test at:
www.cejn.com/movies





Reino Hedman at Midroc Electro AB demonstrates some leakage points and areas of actual danger. Standing at the site you can actually hear the money going up in the air. Around 20-30 % of the total energy consumption is lost due to problems caused by hose clamp leakage and old and inefficient products causing high pressure drop.

CEJN recommends you identify weak spots and carry out an annual leak check. A well planned production site with an optimized flow is the key to good total economy.

2 SPOT YOUR LEAKS!



COMPRESSED AIR LEAKS are a waste that leads to increased energy consumption. They are most commonly found on ceiling pipes, hoses, worn tools, bad or broken couplings and loose hose clamping.

Hole diameter - Volume of leaking air at 8 bar.

- 1 mm 75 l/min
- 3 mm 600 l/min
- 5 mm 1,700 l/min

3 DON'T STRESS YOUR SYSTEM!



AN AIR SYSTEM THAT RUNS at a higher pressure will wear out sooner and put unnecessary stress on tools. Avoid over-production of compressed air and run your system at a lower pressure and use correctly dimensioned hoses, high flow couplings and an air treatment system (FRL).



Reino Hedman, Midroc Electro AB



Old coupling with hose clamps causing leakage and pressure drop



CEJN eSafe for high flow and low pressure drop

SPOTTING LEAKAGES & OPTIMIZING SYSTEMS WITH MIDROC

The cost of compressed air is high and is increasing every day. Experts are focused on how we can develop new forms of energy supply, but Reino Hedman at Midroc Electro AB is more interested in how we can save what we already have.

Saving energy is crucial, both for the sake of the environment but also as the economical advantages for the individual company are astounding. "Often the payoff seems too good to be true" says Reino Hedman, General Manager at Midroc Electro AB, a company involved in leakage control and system optimization at industrial sites around the world.

LEAKAGE CONTROL is the quickest way to save energy and the return of investment is normally 3-6 months. Reino Hedman states that the normal leakage on a site rounds up to about 20%-30% of the total energy consumption and hose clamps are often the weakest link. "A company can lose many thousands of Euro in hose clamps alone. Just a one millimetre hole costs around 800 Euro every year." Midroc often gets contacted when the leakage is obvious because you can actually hear it, but Reino also wants to add that the leakage you can't hear rounds up to about 800-1200 Euro yearly. He continues: "When there are leakages the compressor needs to work harder to provide enough air to the tools and this is where you start losing money".

THE RIGHT PRODUCT AT THE RIGHT PLACE is the next step in the process of optimizing a production site. Even if ineffective hoses are replaced and leaking clamps removed it's also about the right product and knowledge about

air consumption. On the question of what the right product is, Reino Hedman replays: "A high efficiency coupling with a design that permits lower energy consumption and still allows high tool performance. Like the CEJN eSafe with stream-line connection. It's the best on the market!".

Reino also explains that a well-designed blowgun like the CEJN MultiFLOW is optimal because of its high blowing power and minimal air consumption. "Many people choose what they think is a cheaper product, but what they do not know is that the air runs right through it. By using an optimized blowgun you start saving money immediately." Reino continues talking compressor power and states that with optimized products there will be minimum stress on the compressor that provides the system with the valuable compressed air. "With the right products you can run your system on lower pressure and save money!"

"I definitely recommend CEJN because they have the best coupling on the market!"

Reino Hedman **Midroc Electro AB**

CEJN			
 <p>Series 141</p> <p>Profile: CEJN Original, 2,5 mm</p> <p>Flow rate* at 6 bar: 86 with 0,5 bar pr drop</p> <p>One hand operated: Yes</p> <p>Safety available: No</p>	 <p>Series 220</p> <p>Profile: CEJN Original, 5 mm</p> <p>Flow rate* at 6 bar: 580 with 0,5 bar pr drop</p> <p>One hand operated: Yes</p> <p>Safety available: No</p>	 <p>Series 223</p> <p>Profile: Eurostandard 5 mm</p> <p>Flow rate* at 6 bar: 535 with 0,5 bar pr drop</p> <p>One hand operated: Yes</p> <p>Safety available: No</p>	 <p>Series 320</p> <p>Profile: CEJN Original, Eurostandard 7.4 mm</p> <p>Flow rate* at 6 bar: 2250 with 0,5 bar pr drop</p> <p>One hand operated: Yes</p> <p>Safety available: Yes</p>
 <p>Series 326</p> <p>Profile: CEJN Original, 7,4 mm</p> <p>Flow rate* at 6 bar: 725 Stainless with 0,5 bar pr drop</p> <p>One hand operated: Yes</p> <p>Safety available: No</p>	 <p>Series 342</p> <p>Profile: CEJN Original, 7,4 mm Safetylock</p> <p>Flow rate* at 6 bar: 1950 with 0,5 bar pr drop</p> <p>One hand operated: Yes</p> <p>Safety available: Yes</p>	 <p>Series 410</p> <p>Profile: CEJN Original, Eurostandard 10.4 mm</p> <p>Flow rate* at 6 bar: 3900 with 0,5 bar pr drop</p> <p>One hand operated: Yes</p> <p>Safety available: Yes</p>	 <p>Series 442</p> <p>Profile: CEJN Original, 10,4 mm Safetylock</p> <p>Flow rate* at 6 bar: 3950 with 0,5 bar pr drop</p> <p>One hand operated: Yes</p> <p>Safety available: Yes</p>

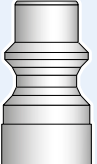
ISO B
 <p>Series 310</p> <p>Profile: ISO 6150 B, A-A 59439, 5,3 mm</p> <p>Flow rate* at 6 bar: 925 with 0,5 bar pr drop</p> <p>One hand operated: Yes</p> <p>Safety available: Yes</p>

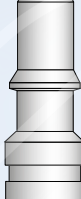
ISO C
 <p>Series 291</p> <p>Profile: ISO 6150 C, 5,5 mm</p> <p>Flow rate* at 6 bar: 640 with 0,5 bar pr drop</p> <p>One hand operated: Yes</p> <p>Safety available: Yes</p>

ARO
 <p>Series 300</p> <p>Profile: ARO 210 Standard, 5,5 mm</p> <p>Flow rate* at 6 bar: 1050 with 0,5 bar pr drop</p> <p>One hand operated: Yes</p> <p>Safety available: Yes</p>

Asian
 <p>Series 315</p> <p>Profile: Asian Standard, 7,5 mm</p> <p>Flow rate* at 6 bar: 1950 with 0,5 bar pr drop</p> <p>One hand operated: Yes</p> <p>Safety available: Yes</p>

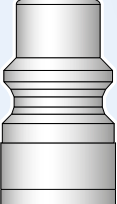
 <p>Series 430</p> <p>Profile: ISO 6150 B, A-A 59439, 8,2 mm</p> <p>Flow rate* at 6 bar: 2350 with 0,5 bar pr drop</p> <p>One hand operated: Yes</p> <p>Safety available: Yes</p>

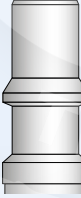
 <p>Series 381</p> <p>Profile: ISO 6150 C, 8 mm</p> <p>Flow rate* at 6 bar: 1050 with 0,5 bar pr drop</p> <p>One hand operated: Yes</p> <p>Safety available: Yes</p>
--

Scandinavian
 <p>Series 303</p> <p>Profile: Scandinavian standard, 6,5 mm</p> <p>Flow rate* at 6 bar: 1450 with 0,5 bar pr drop</p> <p>One hand operated: Yes</p> <p>Safety available: Yes</p>

AC
 <p>Series 331</p> <p>Profile: AC Q10, 7 mm</p> <p>Flow rate* at 6 bar: 1600 with 0,5 bar pr drop</p> <p>One hand operated: Yes</p> <p>Safety available: No</p>

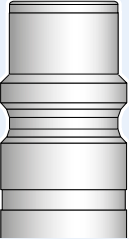
 <p>Series 550</p> <p>Profile: ISO 6150 B, A-A 59439, 11 mm</p> <p>Flow rate* at 6 bar: 3750 with 0,5 bar pr drop</p> <p>One hand operated: Yes</p> <p>Safety available: Yes</p>
--

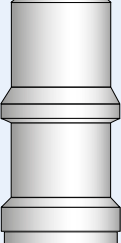
 <p>Series 471</p> <p>Profile: ISO 6150 C, 11 mm</p> <p>Flow rate* at 6 bar: 2350 with 0,5 bar pr drop</p> <p>One hand operated: Yes</p> <p>Safety available: Yes</p>

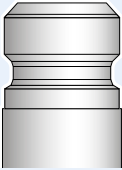
 <p>Series 408</p> <p>Profile: Scandinavian standard, 9,5 mm</p> <p>Flow rate* at 6 bar: 3450 with 0,5 bar pr drop</p> <p>One hand operated: Yes</p> <p>Safety available: Yes</p>
--

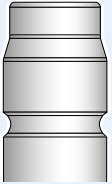
 <p>Series 421</p> <p>Profile: AC Q15, 10 mm</p> <p>Flow rate* at 6 bar: 3200 with 0,5 bar pr drop</p> <p>One hand operated: Yes</p> <p>Safety available: No</p>
--



Couplings & Nipples

- CEJNs core business is connections

All CEJN coupling series are designed to give a high flow and a low pressure drop. These features are made possible through the aerodynamic valve design where air is allowed to flow without unnecessary turbulence. Smooth angles, extra-large ports and a valve spring located outside the flow path gives that extra flow. In addition to that, the design prevents leaking and gives a low connection force.

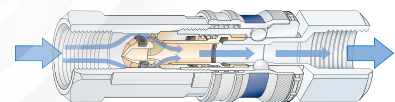

ESAFE – THE NEW GENERATION

Project eSafe had one goal in mind – to eliminate waste for our customers. The patented eSafe coupling has been given the best features on the market with safety function as standard. The new, ground-breaking coupling gives an efficient, ergonomic and energy-saving product – a new CEJN generation of premium coupling for premium performance.

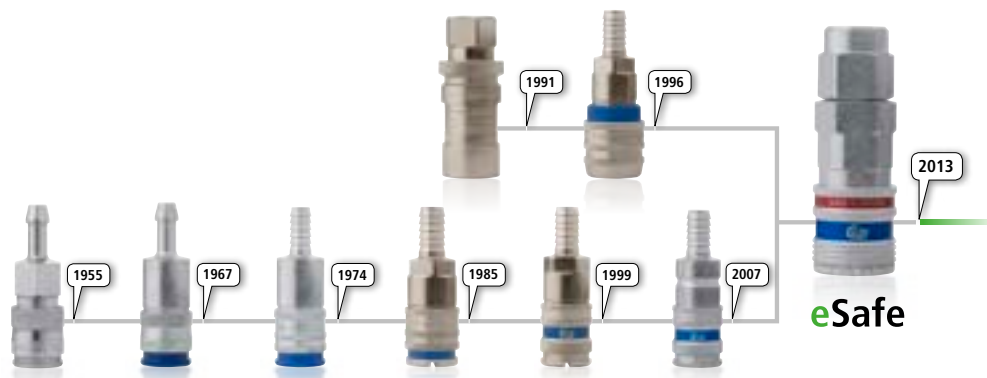

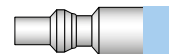

Series 141 – Standard

- **Extremely small external dimensions**
- **One-hand operated**
- **Suitable for several media**

Series 141 mini couplings are among the smallest couplings on the market. The Series offers CEJN's popular product features in a small package and is suitable for fluid and vacuum lines, as well as pneumatic applications.



TECHNICAL DATA

Nominal flow diameter	2.5 mm (3/32")
Air flow.....	86 l/min (3.0 CFM)
Max. working pressure.....	10 bar (145 PSI)
Min. burst pressure.....	40 bar (580 PSI)
Temperature range	-30°C – +100°C (-22°F – +212°F)
Material coupling.....	Chrome-plated brass
Material nipple.....	Chrome-plated brass
Connection force.....	65 N
Markets.....	Global
Standards.....	CEJN Original 2.5 mm

AIR FLOW

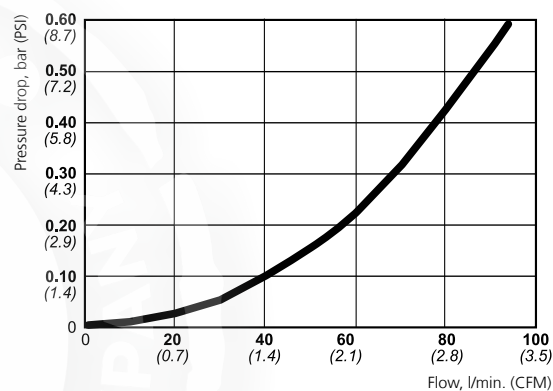

Flow capacity is measured at 6 bar (87 PSI) inlet pressure, and pressure drop at 0.5 bar (7 PSI).

COUPLINGS	HOSE CONNECTION	Part No.	Connection
		10 141 1001	5 mm (3/16")
	MALE THREAD	10 141 1451	NPT 1/8"
		10 141 1251	G 1/8"
	FEMALE THREAD	10 141 1201	G 1/8"

NIPPLES	HOSE CONNECTION	Part No.	Connection
		10 141 5000	3 mm (1/8")
		10 141 5001	5 mm (3/16")
	MALE THREAD	10 141 5151	R 1/8"
		10 141 5251	G 1/8"
		10 141 5451	NPT 1/8"
	FEMALE THREAD	10 141 5201	G 1/8"

1:1

Series 220 – Standard

- High flow capacity
- Small external dimensions
- One-hand operated

Series 220 couplings are suitable for fluid and vacuum applications, as well as compressed air. They offer high flow capacity for a wide range of applications. Safety rings to prevent unintentional disconnection are available on request.

Refer to the CEJN Fluid Products Catalog for specialized versions of Series 220 with brass nipples (Series 221) and two-way shutoff (Series 225). Refer to the CEJN Breathing Air Products Catalog for Series 221 that offers an easy-to-grip locking sleeve.



TECHNICAL DATA

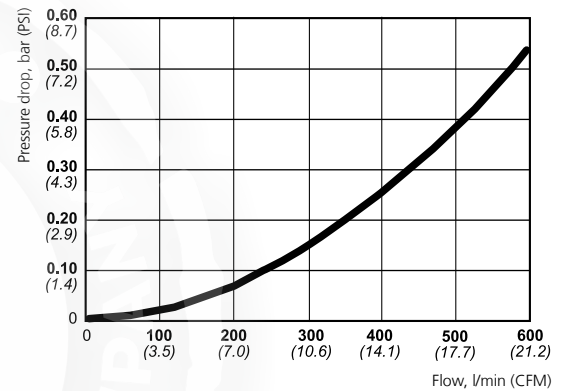

Nominal flow diameter	5.0 mm (3/16")
Air flow.....	580 l/min (20.5 CFM)
Max. working pressure.....	35 bar (507 PSI)
Min. burst pressure.....	140 bar (2030 PSI)
Temperature range	-30°C – +100°C (-22°F – +212°F)
Material coupling.....	Nickel-plated brass
Material nipple.....	Hardened zinc-plated steel
Connection force.....	92 N
Markets.....	Global
Standards.....	CEJN Original, 5 mm

AIR FLOW

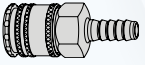
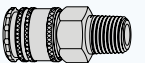
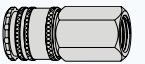

Flow capacity is measured at 6 bar (87 PSI) inlet pressure, and pressure drop at 0.5 bar (7 PSI).

		Part No.	Connection
COUPLINGS	HOSE CONNECTION 	10 220 1001	5 mm (3/16")
		10 220 1002	6.3 mm (1/4")
		10 220 1003	8 mm (5/16")
		10 220 1004	10 mm (3/8")
	MALE THREAD 	10 220 1151	R 1/8"
		10 220 1152	R 1/4"
		10 220 1154	R 3/8"
		10 220 1451	NPT 1/8"
		10 220 1452	NPT 1/4"
		10 220 1454	NPT 3/8"
	FEMALE THREAD 	10 220 1201	G 1/8"
		10 220 1202	G 1/4"
10 220 1204		G 3/8"	
10 220 1401		NPT 1/8"	
10 220 1402		NPT 1/4"	
10 220 1404		NPT 3/8"	

		Part No.	Connection
NIPPLES	HOSE CONNECTION 	10 220 5001	5 mm (3/16")
		10 220 5002	6.3 mm (1/4")
		10 220 5003	8 mm (5/16")
		10 220 5004	10 mm (3/8")
	MALE THREAD 	10 220 5151	R 1/8"
		10 220 5152	R 1/4"
		10 220 5154	R 3/8"
		10 220 5451	NPT 1/8"
		10 220 5452	NPT 1/4"
		10 220 5454	NPT 3/8"
	FEMALE THREAD 	10 220 5201	G 1/8"
		10 220 5202	G 1/4"
10 220 5204		G 3/8"	
10 220 5401		NPT 1/8"	
10 220 5402		NPT 1/4"	
10 220 5404		NPT 3/8"	

CEJN reserves the right to make changes without further notification. Thread connections are listed according to ISO Standards. Other connections and sealing material on request. Check with an authorized CEJN distributor for availability and prices. Some part numbers may be subject to minimum order quantities. Please visit our website, www.cejn.com, for general maintenance tips.

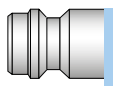

Series 223 – Standard

- Interchangeable with several other brands
- Small external dimensions
- Robust design

Series 223 consists of couplings and nipples, suitable for compressed air, as well as fluid and vacuum applications. All the products in series 223 have small external dimensions, which makes them practical when space is tight. Despite the dimensions, the design is robust and sturdy. The products in Series 223 are interchangeable with several other brands with comparable size.







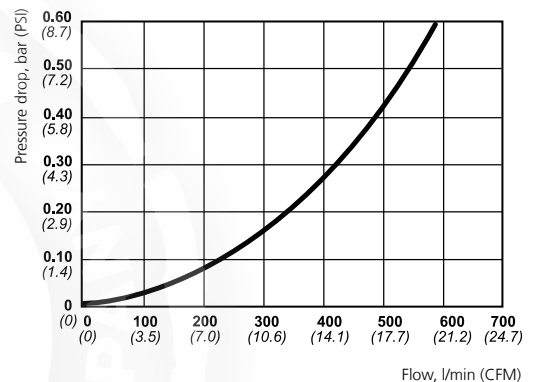

TECHNICAL DATA **AIR FLOW**

Nominal flow diameter 5.0 mm (3/32")
Air flow..... 535 l/min (18.9 CFM)
Max. working pressure..... 15 bar (217 PSI)
Min. burst pressure..... 60 bar (870 PSI)
Temperature range -20°C – +70°C (-4°F – +158°F)
Material coupling..... Nickel-plated brass
Material nipple..... Nickel-plated brass
Connection force..... 63.7 N
Markets..... Global
Standards..... Eurostandard 5 mm



Flow capacity is measured at 6 bar (87 PSI) inlet pressure, and pressure drop at 0.5 bar (7 PSI).

		Part No.	Connection
COUPLINGS	HOSE CONNECTION 	10 223 1930	4 mm (5/32")
		10 223 1932	6 mm (1/4")
	MALE THREAD 	10 223 1951	G 1/8"
		10 223 1952	G 1/4"
	FEMALE THREAD 	10 223 1901	G 1/8"
		10 223 1902	G 1/4"

		Part No.	Connection
NIPPLES	HOSE CONNECTION 	10 223 5930	4 mm (5/32")
		10 223 5932	6 mm (1/4")
	MALE THREAD 	10 223 5951	G 1/8"
		10 223 5952	G 1/4"
	FEMALE THREAD 	10 223 5901	G 1/8"
		10 223 5902	G 1/4"

CEJN reserves the right to make changes without further notification. Thread connections are listed according to ISO Standards. Other connections and sealing material on request. Check with an authorized CEJN distributor for availability and prices. Some part numbers may be subject to minimum order quantities. Please visit our website, www.cejn.com, for general maintenance tips.

1:1

Series 300 – Standard

- One-hand operated
- Strong and durable
- High flow capacity

Series 300 couplings offer high flow and require only a low connection force, which ensures a safe working environment. Male threads on the couplings and nipples feature pre-applied thread sealant.

The Series eSafe 300 version is disconnected in two stages in order to vent the coupling and minimize the risk of sudden component separation, which has the potential to cause operator injury. The one-handed operation ensures easy handling. The eSafe version complies with ISO Standard 4414 and EN 983.

Series 300 is available in eSafe, Soft-Line and Multi-Link versions.



TECHNICAL DATA

Nominal flow diameter	5.5 mm (7/32")
Air flow	1050 l/min (37.1 CFM)
Max. working pressure	16 bar (232 PSI)
Min. burst pressure	140 bar (2030 PSI)
Temperature range	-20°C – +100°C (-4°F – +212°F)
Material coupling	Zinc-plated steel/brass
Material nipple	Hardened zinc-plated steel
Connection force	70.7 N
Markets	Benelux, North America, Switzerland
Standards	ARO 210 Standard, 5.5 mm

AIR FLOW

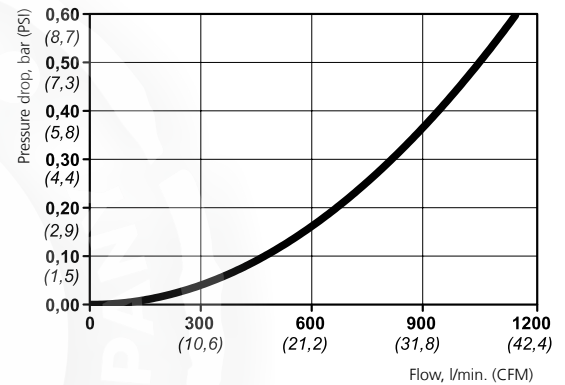

Flow capacity is measured at 6 bar (87 PSI) inlet pressure, and pressure drop at 0.5 bar (7 PSI)

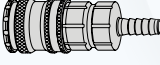
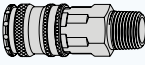
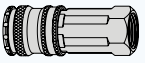
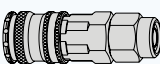
COUPLINGS	Part No.	Connection
HOSE CONNECTION 	10 300 1002	6.3 mm (1/4")
	10 300 1003	8 mm (5/16")
	10 300 1004	10 mm (3/8")
MALE THREAD 	10 300 1152	R 1/4"
	10 300 1154	R 3/8"
	10 300 1155	R 1/2"
	10 300 1452	NPT 1/4"
FEMALE THREAD 	10 300 1202	G 1/4"
	10 300 1204	G 3/8"
	10 300 1402	NPT 1/4"
STREAM-LINE CONNECTION 	10 300 1060	6.5x10 mm
	10 300 1062	8x12 mm
	10 300 1066	11x16 mm

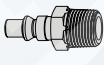
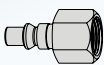
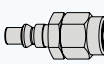
NIPPLES	Part No.	Connection
HOSE CONNECTION 	10 300 5002	6.3 mm (1/4")
	10 300 5003	8 mm (5/16")
	10 300 5004	10 mm (3/8")
MALE THREAD 	10 300 5151	R 1/8"
	10 300 5152	R 1/4"
	10 300 5154	R 3/8"
	10 300 5155	R 1/2"
	10 300 5451	NPT 1/8"
	10 300 5452	NPT 1/4"
FEMALE THREAD 	10 300 5454	NPT 3/8"
	10 300 5201	G 1/8"
	10 300 5202	G 1/4"
	10 300 5204	G 3/8"
STREAM-LINE CONNECTION 	10 300 5401	NPT 1/8"
	10 300 5402	NPT 1/4"
	10 300 5404	NPT 3/8"
	10 300 5058	5 x 8 mm
	10 300 5060	6.5 x 10 mm
	10 300 5062	8 x 12 mm
10 300 5063	9.5 x 13.5 mm	
10 300 5066	11 x 16 mm	

CEJN reserves the right to make changes without further notification. Thread connections are listed according to ISO Standards. Other connections and sealing material on request. Check with an authorized CEJN distributor for availability and prices. Some part numbers may be subject to minimum order quantities. Please visit our website, www.cejn.com, for general maintenance tips.

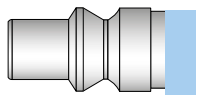

Series 300 – eSafe

- Vented safety function
- High flow capacity
- Strong and durable

Series 300 eSafe couplings offer high flow and require only a low connection force, which ensures a safe working environment. eSafe is a one hand operated safety coupling that vents before disconnection eliminating the risk of hose whip. Male threads on the couplings and nipples feature pre-applied thread sealant. A fully automatic operation ensures quick and easy handling. eSafe complies with ISO Standard 4414 and EN 983.

Series 300 is also available in standard, Soft-Line and Multi-Link versions.

eSafe™







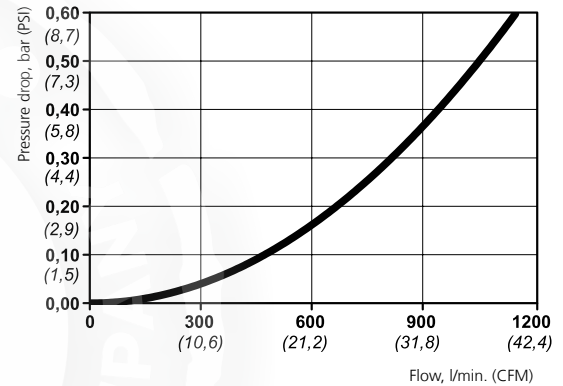

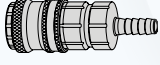
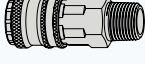

TECHNICAL DATA **AIR FLOW**

Nominal flow diameter 5.5 mm (7/32")
Air flow..... 1050 l/min (37.1 CFM)
Max. working pressure..... 16 bar (232 PSI)
Min. burst pressure..... 140 bar (2030 PSI)
Temperature range -20°C – +100°C (-4°F – +212°F)
Material coupling..... Zinc-plated steel/brass
Material nipple..... Hardened zinc-plated steel
Connection force..... 86 N
Markets..... Benelux, North America, Switzerland
Standards..... ARO 210 Standard, 5.5 mm



Flow capacity is measured at 6 bar (87 PSI) inlet pressure, and pressure drop at 0.5 bar (7 PSI)

Icon	Part No.	Connection	
ESAFE VENTED SAFETY COUPLING 	HOSE CONNECTION		
	10 300 2002	6.3 mm (1/4")	
	10 300 2003	8 mm (5/16")	
	10 300 2009	9 mm	
	10 300 2004	10 mm (3/8")	
	10 300 2005	13 mm (1/2")	
	MALE THREAD 	10 300 2152	R 1/4"
		10 300 2154	R 3/8"
		10 300 2155	R 1/2"
		10 300 2452	NPT 1/4"
		10 300 2454	NPT 3/8"
	FEMALE THREAD 	10 300 2455	NPT 1/2"
		10 300 2202	G 1/4"
		10 300 2204	G 3/8"
		10 300 2205	G 1/2"
10 300 2402		NPT 1/4"	
STREAM-LINE CONNECTION 	10 300 2404	NPT 3/8"	
	10 300 2405	NPT 1/2"	
	10 300 2058	5 x 8 mm	
	10 300 2060	6.5 x 10 mm	
	10 300 2062	8 x 12 mm	
	10 300 2063	9.5 x 13.5 mm	
ESAFE SOFT-LINE COUPLING 	10 300 2066	11 x 16 mm	
	10 300 2080	6.5 x 10 mm	
	10 300 2082	8 x 12 mm	

Icon	Part No.	Connection
NIPPLES 	HOSE CONNECTION	
	10 300 5002	6.3 mm (1/4")
	10 300 5003	8 mm (5/16")
	10 300 5004	10 mm (3/8")
MALE THREAD 	10 300 5151	R 1/8"
	10 300 5152	R 1/4"
	10 300 5154	R 3/8"
	10 300 5155	R 1/2"
	10 300 5451	NPT 1/8"
	10 300 5452	NPT 1/4"
FEMALE THREAD 	10 300 5454	NPT 3/8"
	10 300 5201	G 1/8"
	10 300 5202	G 1/4"
	10 300 5204	G 3/8"
	10 300 5401	NPT 1/8"
STREAM-LINE CONNECTION 	10 300 5402	NPT 1/4"
	10 300 5404	NPT 3/8"
	10 300 5058	5 x 8 mm
	10 300 5060	6.5 x 10 mm
	10 300 5062	8 x 12 mm
	10 300 5063	9.5 x 13.5 mm
	10 300 5066	11 x 16 mm

CEJN reserves the right to make changes without further notification. Thread connections are listed according to ISO Standards. Other connections and sealing material on request. Check with an authorized CEJN distributor for availability and prices. Some part numbers may be subject to minimum order quantities. Please visit our website, www.cejn.com, for general maintenance tips.

1:1

Series 303 – Standard

- Strong and durable
- One-hand operated
- Low connection force

Series 303 couplings offer high-flow capacity and are insensitive to vibrations. A wide range of connections is included in the Series, which is also suitable for vacuum service. Male threads on the couplings and nipples feature pre-applied thread sealant.



TECHNICAL DATA

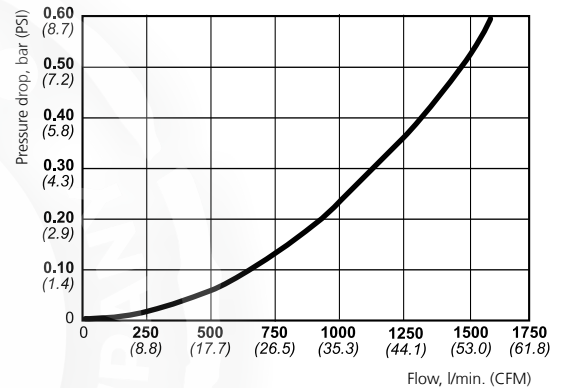

Nominal flow diameter	6.5 mm (1/4")
Air flow	1450 l/min (51.2 CFM)
Max. working pressure	16 bar (232 PSI)
Min. burst pressure	140 bar (2030 PSI)
Temperature range	-20°C – +100°C (-4°F – +212°F)
Material coupling	Zinc-plated steel/brass
Material nipple	Hardened zinc-plated steel
Connection force	85 N
Markets	Finland, Sweden
Standards	Scandinavian Standard, 6.5 mm

AIR FLOW

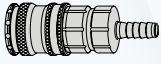
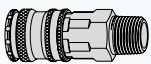
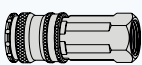
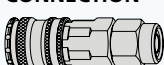

Flow capacity is measured at 6 bar (87 PSI) inlet pressure, and pressure drop at 0.5 bar (7 PSI).

COUPLINGS	Part No.	Connection
HOSE CONNECTION 	10 303 1002	6.3 mm (1/4")
	10 303 1003	8 mm (5/16")
	10 303 1004	10 mm (3/8")
	10 303 1005	13 mm (1/2")
MALE THREAD 	10 303 1152	R 1/4"
	10 303 1154	R 3/8"
	10 303 1155	R 1/2"
FEMALE THREAD 	10 303 1202	G 1/4"
	10 303 1204	G 3/8"
	10 303 1205	G 1/2"
STREAM-LINE CONNECTION 	10 303 1058	5x8 mm
	10 303 1060	6.5x10 mm
	10 303 1062	8x12 mm
	10 303 1063	9.5x13.5 mm
	10 303 1066	11x16 mm

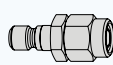
NIPPLES	Part No.	Connection
HOSE CONNECTION 	10 303 5002	6.3 mm (1/4")
	10 303 5003	8 mm (5/16")
	10 303 5004	10 mm (3/8")
	10 303 5005	13 mm (1/2")
MALE THREAD 	10 303 5151	R 1/8"
	10 303 5152	R 1/4"
	10 303 5154	R 3/8"
	10 303 5155	R 1/2"
FEMALE THREAD 	10 303 5201	G 1/8"
	10 303 5202	G 1/4"
	10 303 5204	G 3/8"
	10 303 5205	G 1/2"
STREAM-LINE CONNECTION 	10 303 5058	5x8 mm
	10 303 5060	6.5x10 mm
	10 303 5062	8x12 mm
	10 303 5063	9.5x13.5 mm
	10 303 5066	11x16 mm

CEJN reserves the right to make changes without further notification. Thread connections are listed according to ISO Standards. Other connections and sealing material on request. Check with an authorized CEJN distributor for availability and prices. Some part numbers may be subject to minimum order quantities. Please visit our website, www.cejn.com, for general maintenance tips.

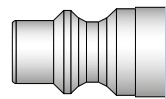

Series 310 – Standard

- High flow capacity
- One-hand operated
- Low connection force

Series 310 offers a wide range of easy-to-grip couplings, including Soft-Line, Stream-Line, and Multi-Link couplings. Male threads on the couplings and nipples feature pre-applied thread sealant. The Series eSafe 310 version is disconnected in two stages in order to vent the coupling and minimize the risk of sudden component separation, which has the potential to cause operator injury. The one-handed operation ensures easy handling. The eSafe version complies with ISO Standard 4414 and EN 983.

Series 310 is available in eSafe, Soft-Line and Multi-Link versions.



TECHNICAL DATA **AIR FLOW**

Nominal flow diameter 5.3 mm (7/32")
 Air flow..... 925 l/min (32.7 CFM)
 Max. working pressure..... 16 bar (232 PSI)
 Min. burst pressure..... 140 bar (2030 PSI)
 Temperature range -20°C – +100°C (-4°F – +212°F)
 Material coupling..... Zinc-plated steel/brass
 Material nipple..... Hardened zinc-plated steel
 Connection force..... 70.7 N
 Markets..... Benelux, France, North America, Norway
 Standards..... ISO 6150 B, A-A 59439 5.3 mm

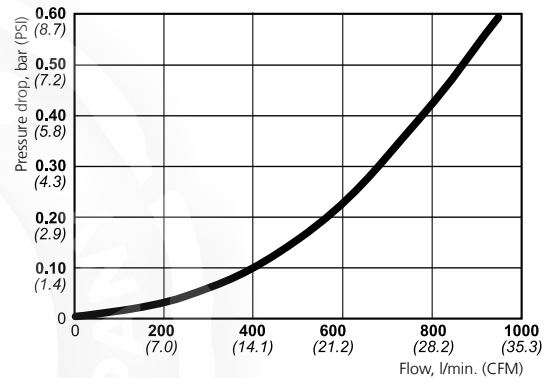

Flow capacity is measured at 6 bar (87 PSI) inlet pressure, and pressure drop at 0.5 bar (7 PSI).

COUPLINGS	HOSE CONNECTION	Part No.	Connection
		10 310 1002	6.3 mm (1/4")
		10 310 1003	8 mm (5/16")
		10 310 1004	10 mm (3/8")
		10 310 1005	13 mm (1/2")
	MALE THREAD	10 310 1152	R 1/4"
		10 310 1154	R 3/8"
		10 310 1155	R 1/2"
		10 310 1452	NPT 1/4"
		10 310 1454	NPT 3/8"
	FEMALE THREAD	10 310 1455	NPT 1/2"
		10 310 1202	G 1/4"
		10 310 1204	G 3/8"
		10 310 1205	G 1/2"
		10 310 1402	NPT 1/4"
		10 310 1404	NPT 3/8"
	STREAM-LINE CONNECTION	10 310 1405	NPT 1/2"
		10 310 1058	5x8 mm
		10 310 1060	6.5x10 mm
		10 310 1062	8x12 mm
		10 310 1063	9.5x13.5 mm
	SOFT-LINE COUPLINGS	10 310 1066	11x16 mm
		10 310 1083	6.5 x 10 mm
	STREAM-LINE CONNECTION	10 310 1084	8 x 12 mm
		10 310 1240	G 1/4"
	FEMALE THREAD	10 310 1241	G 3/8"
		10 310 1446	NPT 1/4"
		10 310 1447	NPT 3/8"

NIPPLES	HOSE CONNECTION	Part No.	Connection
		10 310 5001	5 mm (3/16")
		10 310 5002	6.3 mm (1/4")
		10 310 5003	8 mm (5/16")
		10 310 5004	10 mm (3/8")
		10 310 5005	13 mm (1/2")
	MALE THREAD	10 310 5151	R 1/8"
		10 310 5152	R 1/4"
		10 310 5154	R 3/8"
		10 310 5252	G 1/4"
		10 310 5451	NPT 1/8"
		10 310 5452	NPT 1/4"
		10 310 5454	NPT 3/8"
		10 310 5455	NPT 1/2"
	FEMALE THREAD	10 310 5201	G 1/8"
		10 310 5202	G 1/4"
		10 310 5204	G 3/8"
		10 310 5401	NPT 1/8"
	STREAM-LINE CONNECTION	10 310 5402	NPT 1/4"
		10 310 5404	NPT 3/8"
		10 310 5058	5 x 8 mm
		10 310 5060	6.5 x 10 mm
		10 310 5062	8 x 12 mm
	10 310 5063	9.5 x 13.5 mm	
	10 310 5066	11 x 16 mm	

CEJN reserves the right to make changes without further notification. Thread connections are listed according to ISO Standards. Other connections and sealing material on request. Check with an authorized CEJN distributor for availability and prices. Some part numbers may be subject to minimum order quantities. Please visit our website, www.cejn.com, for general maintenance tips.

1:1

Series 310 – eSafe

- Vented safety function
- High flow capacity
- Strong and durable

eSafe Series 310 offers a wide range of easy-to-grip couplings, including Soft-Line and Stream-Line. Male threads on the couplings and nipples feature pre-applied thread sealant. eSafe Series 310 is a vented safety coupling that is disconnected in two stages in order to vent the coupling and minimize the risk of sudden component separation. The coupling is fully automatic to ensure quick and easy handling. eSafe series complies with ISO Standard 4414 and EN 983.

Series 310 is also available in standard, Soft-Line and Multi-Link versions.

eSafe™



TECHNICAL DATA **AIR FLOW**

Nominal flow diameter.....	5.3 mm (7/32")
Air flow.....	950 l/min (33.5 CFM)
Max. working pressure.....	16 bar (232 PSI)
Min. burst pressure.....	140 bar (2030 PSI)
Temperature range.....	-20°C – +100°C (-4°F – +212°F)
Material coupling.....	Zinc-plated steel/brass
Material nipple.....	Hardened zinc-plated steel
Connection force.....	86 N
Markets.....	Benelux, France, North America, Norway
Standards.....	ISO 6150 B, A-A 59439 5.3 mm

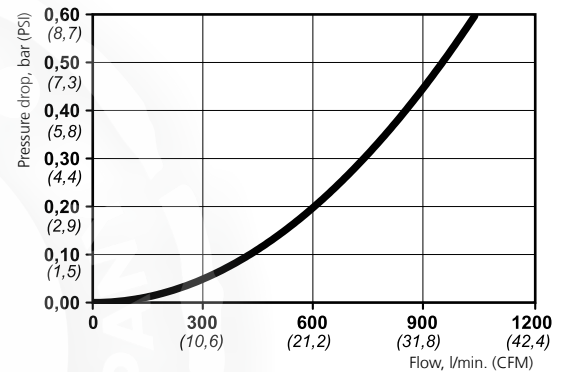

Flow capacity is measured at 6 bar (87 PSI) inlet pressure, and pressure drop at 0.5 bar (7 PSI).

Icon	Part No.	Connection
ESAFE VENTED SAFETY COUPLING 	HOSE CONNECTION	
	10 310 2002	6.3 mm (1/4")
	10 310 2003	8 mm (5/16")
	10 310 2009	9 mm
	10 310 2004	10 mm (3/8")
	10 310 2005	13 mm (1/2")
	MALE THREAD	
	10 310 2152	R 1/4"
	10 310 2154	R 3/8"
	10 310 2155	R 1/2"
	10 310 2452	NPT 1/4"
	10 310 2454	NPT 3/8"
	10 310 2455	NPT 1/2"
	FEMALE THREAD	
	10 310 2202	G 1/4"
10 310 2204	G 3/8"	
10 310 2205	G 1/2"	
10 310 2402	NPT 1/4"	
10 310 2404	NPT 3/8"	
10 310 2405	NPT 1/2"	
STREAM-LINE CONNECTION		
10 310 2058	5 x 8 mm	
10 310 2060	6.5 x 10 mm	
10 310 2062	8 x 12 mm	
10 310 2063	9.5 x 13.5 mm	
10 310 2066	11 x 16 mm	
ESAFE SOFT-LINE COUPLING 	STREAM-LINE CONNECTION	
	10 310 2080	6.5 x 10 mm
	10 310 2082	8 x 12 mm
	FEMALE THREAD	
	10 310 2232	G 1/4"
10 310 2432	NPT 1/4"	

Icon	Part No.	Connection
NIPPLES 	HOSE CONNECTION	
	10 310 5001	5 mm (3/16")
	10 310 5002	6.3 mm (1/4")
	10 310 5003	8 mm (5/16")
	10 310 5004	10 mm (3/8")
	10 310 5005	13 mm (1/2")
	MALE THREAD	
	10 310 5151	R 1/8"
	10 310 5152	R 1/4"
	10 310 5154	R 3/8"
	10 310 5252	G 1/4"
	10 310 5451	NPT 1/8"
	10 310 5452	NPT 1/4"
	10 310 5454	NPT 3/8"
	10 310 5455	NPT 1/2"
FEMALE THREAD		
10 310 5201	G 1/8"	
10 310 5202	G 1/4"	
10 310 5204	G 3/8"	
10 310 5401	NPT 1/8"	
10 310 5402	NPT 1/4"	
10 310 5404	NPT 3/8"	
STREAM-LINE CONNECTION		
10 310 5058	5 x 8 mm	
10 310 5060	6.5 x 10 mm	
10 310 5062	8 x 12 mm	
10 310 5063	9.5 x 13.5 mm	
10 310 5066	11 x 16 mm	

CEJN reserves the right to make changes without further notification. Thread connections are listed according to ISO Standards. Other connections and sealing material on request. Check with an authorized CEJN distributor for availability and prices. Some part numbers may be subject to minimum order quantities. Please visit our website, www.cejn.com, for general maintenance tips.

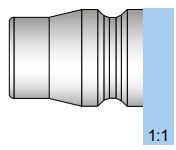

Series 315 – Standard

- **Extremely high flow capacity**
- **Low connection force**
- **One-hand operated**

Series 315 couplings are lightweight and easy to handle yet strong and durable. The Series includes a wide range of connections as well as anti-hose whip nipples. The Series eSafe 315 version is disconnected in two stages in order to vent the coupling and minimize the risk of sudden component separation, which has the potential to cause operator injury. The one-handed operation ensures easy handling. The eSafe version complies with ISO Standard 4414 and EN 983.

Series 315 is available in eSafe and Multi-Link versions.



TECHNICAL DATA

Nominal flow diameter	7.5 mm (5/16")
Air flow	1950 l/min (68.8 CFM)
Max. working pressure	16 bar (232 PSI)
Min. burst pressure	140 bar (2030 PSI)
Temperature range	-20°C – +100°C (-4°F – +212°F)
Material coupling	Zinc-plated steel/brass
Material nipple	Hardened zinc-plated steel
Connection force	73.5 N
Markets	Asia, Australia, Italy, South America
Standards	Asian Standard, 7.5 mm

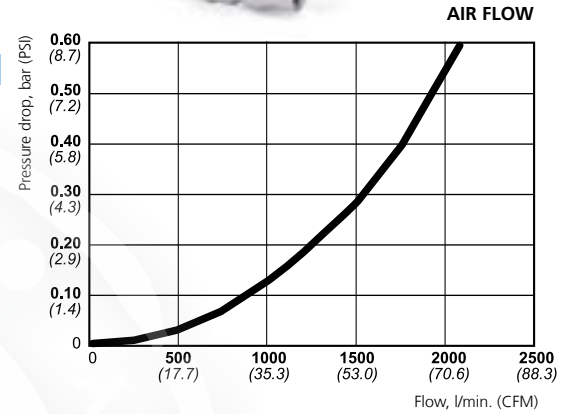

Flow capacity is measured at 6 bar (87 PSI) inlet pressure, and pressure drop at 0.5 bar (7 PSI).

COUPLINGS	HOSE CONNECTION	Part No.	Connection
		10 315 1002	6.3 mm
		10 315 1043	9 mm
		10 315 1004	10 mm
		10 315 1005	13 mm
	MALE THREAD	10 315 1152	R 1/4"
		10 315 1154	R 3/8"
		10 315 1155	R 1/2"
		10 315 1452	NPT 1/4"
		10 315 1454	NPT 3/8"
		10 315 1455	NPT 1/2"
	FEMALE THREAD	10 315 1102	Rc 1/4"
		10 315 1104	Rc 3/8"
		10 315 1105	Rc 1/2"
		10 315 1402	NPT 1/4"
		10 315 1404	NPT 3/8"
		10 315 1405	NPT 1/2"
	STREAM-LINE CONNECTION	10 315 1058	5 x 8 mm
		10 315 1060	6.5 x 10 mm
		10 315 1062	8 x 12 mm
		10 315 1066	11 x 16 mm

NIPPLES	HOSE CONNECTION	Part No.	Connection	
		10 315 5001	5 mm (3/16")	
		10 315 5002	6.3 mm (1/4")	
		10 315 5043	7 mm (9/32")	
		10 315 5004	10 mm (3/8")	
		10 315 5005	13 mm (1/2")	
	MALE THREAD	10 315 5151	R 1/8"	
		10 315 5152	R 1/4"	
		10 315 5154	R 3/8"	
		10 315 5155	R 1/2"	
		10 315 5452	NPT 1/4"	
		10 315 5454	NPT 3/8"	
		10 315 5455	NPT 1/2"	
		10 315 5101	Rc 1/8"	
	FEMALE THREAD	10 315 5102	Rc 1/4"	
		10 315 5104	Rc 3/8"	
		10 315 5105	Rc 1/2"	
		10 315 5402	NPT 1/4"	
		10 315 5404	NPT 3/8"	
		10 315 5405	NPT 1/2"	
		STREAM-LINE CONNECTION	10 315 5058	5 x 8 mm
			10 315 5060	6.5 x 10 mm
		10 315 5062	8 x 12 mm	
		10 315 5063	9.5 x 13.5 mm	
		10 315 5066	11 x 16 mm	

CEJN reserves the right to make changes without further notification. Thread connections are listed according to ISO Standards. Other connections and sealing material on request. Check with an authorized CEJN distributor for availability and prices. Some part numbers may be subject to minimum order quantities. Please visit our website, www.cejn.com, for general maintenance tips.

1:1

Series 315 – eSafe

- Vented safety function
- Extremely high flow capacity
- Strong and durable

eSafe Series 315 couplings are lightweight and easy to handle yet strong and durable. It is a one hand operated safety coupling that vents before disconnection eliminating the risk of hose whip. The Series includes a wide range of connections. Male threads on the couplings and nipples feature pre-applied thread sealant. Full automatic operation ensures easy handling. eSafe complies with ISO Standard 4414 and EN 983.

Series 315 is also available in standard, Soft-Line and Multi-Link versions.

eSafe™



TECHNICAL DATA **AIR FLOW**

Nominal flow diameter 7.5 mm (5/16")
Air flow..... 1950 l/min (68.8 CFM)
Max. working pressure..... 16 bar (232 PSI)
Min. burst pressure..... 140 bar (2030 PSI)
Temperature range -20°C – +100°C (-4°F – +212°F)
Material coupling..... Zinc-plated steel/brass
Material nipple..... Hardened zinc-plated steel
Connection force..... 86 N
Markets..... Asia, Australia, Italy, South America
Standards..... Asian standard, 7.5 mm

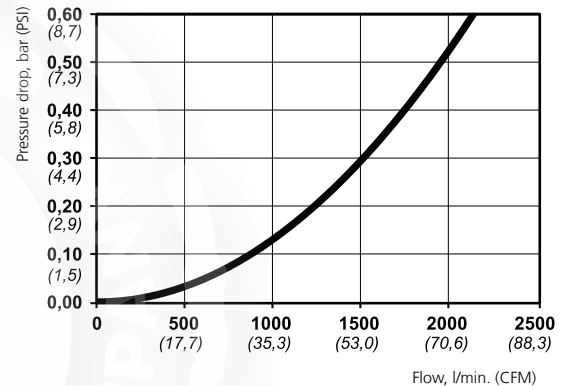

Flow capacity is measured at 6 bar (87 PSI) inlet pressure, and pressure drop at 0.5 bar (7 PSI).

Icon	Part No.	Connection
	HOSE CONNECTION 	10 315 2002 6.3 mm (1/4")
		10 315 2043 7 mm (9/32")
		10 315 2004 10 mm (3/8")
		10 315 2005 13 mm (1/2")
	MALE THREAD 	10 315 2152 R 1/4"
		10 315 2154 R 3/8"
		10 315 2155 R 1/2"
		10 315 2452 NPT 1/4"
		10 315 2454 NPT 3/8"
		10 315 2455 NPT 1/2"
	FEMALE THREAD 	10 315 2102 Rc 1/4"
		10 315 2104 Rc 3/8"
		10 315 2105 Rc 1/2"
		10 315 2202 G 1/4"
		10 315 2204 G 3/8"
10 315 2402 NPT 1/4"		
10 315 2404 NPT 3/8"		
10 315 2405 NPT 1/2"		
STREAM-LINE CONNECTION 	10 315 2058 5 x 8 mm	
	10 315 2060 6.5 x 10 mm	
	10 315 2062 8 x 12 mm	
	10 315 2063 9.5 x 13.5 mm	
	10 315 2066 11 x 16 mm	
ESAFE SOFT-LINE COUPLING 	10 315 2080 6.5 x 10 mm	
	10 315 2082 8 x 12 mm	

Icon	Part No.	Connection
	HOSE CONNECTION 	10 315 5001 5 mm (3/16")
		10 315 5002 6.3 mm (1/4")
		10 315 5043 7 mm (9/32")
		10 315 5004 10 mm (3/8")
		10 315 5005 13 mm (1/2")
MALE THREAD 	10 315 5151 R 1/8"	
	10 315 5152 R 1/4"	
	10 315 5154 R 3/8"	
	10 315 5155 R 1/2"	
	10 315 5452 NPT 1/4"	
	10 315 5454 NPT 3/8"	
FEMALE THREAD 	10 315 5455 NPT 1/2"	
	10 315 5101 Rc 1/8"	
	10 315 5102 Rc 1/4"	
	10 315 5104 Rc 3/8"	
	10 315 5105 Rc 1/2"	
STREAM-LINE CONNECTION 	10 315 5402 NPT 1/4"	
	10 315 5404 NPT 3/8"	
	10 315 5405 NPT 1/2"	
	10 315 5058 5 x 8 mm	
	10 315 5060 6.5 x 10 mm	
	10 315 5062 8 x 12 mm	
	10 315 5063 9.5 x 13.5 mm	
10 315 5066 11 x 16 mm		

CEJN reserves the right to make changes without further notification. Thread connections are listed according to ISO Standards. Other connections and sealing material on request. Check with an authorized CEJN distributor for availability and prices. Some part numbers may be subject to minimum order quantities. Please visit our website, www.cejn.com, for general maintenance tips.

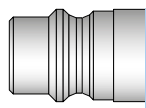

Series 320 – Standard

- **Extremely high flow capacity**
- **One-hand operated**
- **Strong and durable**

Series 320 couplings feature the original high-flow valve design upon which all other CEJN pneumatic couplings are based. Their popularity has made Series 320 a European standard. The Series is easy-to-handle and one-hand operated and offers long service life. Male threads on the couplings and nipples feature pre-applied thread sealant. Lightweight aluminum styles are also available. The Series eSafe 320 version is disconnected in two stages in order to vent the coupling and minimize the risk of sudden component separation, which has the potential to cause operator injury. The one-hand operation ensures easy handling. The eSafe version complies with ISO Standard 4414 and EN 983.

Series 320 is available in eSafe, Lightweight, Soft-Line and Multi-Link versions. Please refer to the CEJN Fluid range for specialized versions of Series 320 with two-way shutoff (Series 324) and stainless steel design (Series 326).



TECHNICAL DATA

Nominal flow diameter	7.6 mm (5/16")
Air flow	2100 l/min (74.1 CFM)
Max. working pressure	16 bar (232 PSI)
Min. burst pressure	140 bar (2030 PSI)
Temperature range	-20°C – +100°C (-4°F – +212°F)
Material coupling	Zinc-plated steel/brass
Material nipple	Hardened zinc-plated steel
Connection force	70.7 N
Markets	Global
Standards	CEJN Original, Eurostandard, 7.4 mm

Flow capacity is measured at 6 bar (87 PSI) inlet pressure, and pressure drop at 0.5 bar (7 PSI).

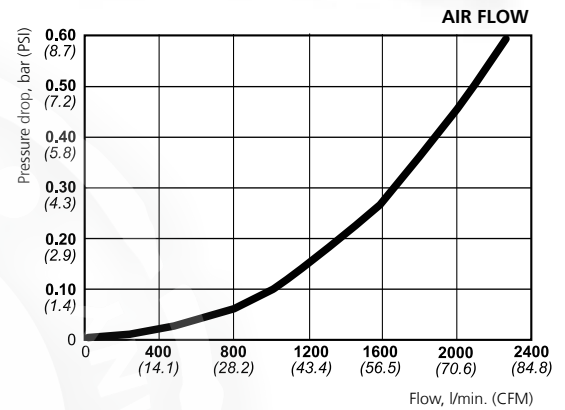

COUPLINGS	Part No.	Connection	
HOSE CONNECTION 	10 320 1002	6.3 mm (1/4")	
	10 320 1003	8 mm (5/16")	
	10 320 1009	9 mm	
	10 320 1004	10 mm (3/8")	
	10 320 1005	13 mm (1/2")	
	MALE THREAD 	10 320 1152	R 1/4"
		10 320 1154	R 3/8"
		10 320 1155	R 1/2"
		10 320 1452	NPT 1/4"
		10 320 1454	NPT 3/8"
	FEMALE THREAD 	10 320 1455	NPT 1/2"
		10 320 1202	G 1/4"
		10 320 1204	G 3/8"
		10 320 1205	G 1/2"
		10 320 1402	NPT 1/4"
STREAM-LINE CONNECTION 	10 320 1404	NPT 3/8"	
	10 320 1405	NPT 1/2"	
	10 320 1058	5x8 mm	
	10 320 1060	6.5x10 mm	
	10 320 1062	8x12 mm	
SOFT-LINE COUPLINGS 	10 320 1063	9.5x13.5 mm	
	10 320 1066	11x16 mm	
	10 320 1086	10 mm (3/8")	
	10 320 1087	13 mm (1/2")	
	STREAM-LINE CONNECTION 	10 320 1089	6.5 x 10 mm
10 320 1090		8 x 12 mm	
FEMALE THREAD 		10 320 1246	G 1/4"
	10 320 1247	G 3/8"	

NIPPLES	Part No.	Connection	
HOSE CONNECTION 	10 320 5001	5 mm (3/16")	
	10 320 5002	6.3 mm (1/4")	
	10 320 5003	8 mm (5/16")	
	10 320 5009	9 mm	
	10 320 5004	10 mm (3/8")	
	10 320 5005	13 mm (1/2")	
	MALE THREAD 	10 320 5151	R 1/8"
		10 320 5152	R 1/4"
		10 320 5154	R 3/8"
		10 320 5155	R 1/2"
10 320 5263		G 3/8"	
FEMALE THREAD 	10 320 5264	G 1/2"	
	10 320 5265	G 1/2"	
	10 320 5451	NPT 1/8"	
	10 320 5452	NPT 1/4"	
	10 320 5454	NPT 3/8"	
STREAM-LINE CONNECTION 	10 320 5455	NPT 1/2"	
	10 320 5201	G 1/8"	
	10 320 5202	G 1/4"	
	10 320 5204	G 3/8"	
	10 320 5205	G 1/2"	
	10 320 5401	NPT 1/8"	
	10 320 5402	NPT 1/4"	
	10 320 5404	NPT 3/8"	
	10 320 5405	NPT 1/2"	
	10 320 5058	5 x 8 mm	
10 320 5060	6.5 x 10 mm		
10 320 5062	8 x 12 mm		
10 320 5063	9.5 x 13.5 mm		
10 320 5066	11 x 16 mm		
10 320 5068	13 x 18 mm		

CEJN reserves the right to make changes without further notification. Thread connections are listed according to ISO Standards. Other connections and sealing material on request. Check with an authorized CEJN distributor for availability and prices. Some part numbers may be subject to minimum order quantities. Please visit our website, www.cejn.com, for general maintenance tips.

1:1

Series 320 – eSafe

- Vented safety function
- Extremely high flow capacity
- Strong and durable

eSafe Series 320 coupling is an easy-to-handle high performing coupling with a long service life. eSafe is a one hand operated safety coupling that vents before disconnection eliminating the risk of hose whip. Male threads on the couplings and nipples feature pre-applied thread sealant. The couplings have a smaller outside dimension than comparable designs. Full automatic operation ensures easy handling. eSafe complies with ISO Standard 4414 and EN 983.

Series 320 is also available in standard, Soft-Line and Multi-Link versions.



CEJN Safety
AIR FLOW

TECHNICAL DATA

Nominal flow diameter	7.6 mm (5/16")
Air flow	2250 l/min (79.4 CFM)
Max. working pressure	16 bar (232 PSI)
Min. burst pressure	140 bar (2030 PSI)
Temperature range	-20°C – +100°C (-4°F – +212°F)
Material coupling	Zinc-plated steel/brass
Material nipple	Hardened zinc-plated steel
Connection force	86 N
Markets	Global
Standards	CEJN Original, Eurostandard 7.4 mm

Flow capacity is measured at 6 bar (87 PSI) inlet pressure, and pressure drop at 0.5 bar (7 PSI).

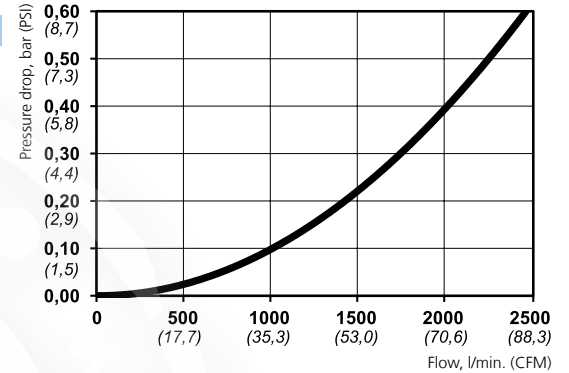

Icon	Part No.	Connection
	HOSE CONNECTION	
	10 320 2002	6.3 mm (1/4")
	10 320 2003	8 mm (5/16")
	10 320 2004	10 mm (3/8")
	10 320 2005	13 mm (1/2")
	10 320 2009	9 mm
	MALE THREAD	
	10 320 2152	R 1/4"
	10 320 2154	R 3/8"
	10 320 2155	R 1/2"
	10 320 2452	NPT 1/4"
	10 320 2454	NPT 3/8"
	10 320 2455	NPT 1/2"
	FEMALE THREAD	
	10 320 2202	G 1/4"
10 320 2204	G 3/8"	
10 320 2205	G 1/2"	
10 320 2402	NPT 1/4"	
10 320 2404	NPT 3/8"	
10 320 2405	NPT 1/2"	
STREAM-LINE CONNECTION		
10 320 2058	5 x 8 mm	
10 320 2060	6.5 x 10 mm	
10 320 2062	8 x 12 mm	
10 320 2063	9.5 x 13.5 mm	
10 320 2066	11 x 16 mm	
	HOSE CONNECTION	
	10 320 2086	10 mm (3/8")
	10 320 2087	13 mm (1/2")
	STREAM-LINE CONNECTION	
	10 320 2080	6.5 x 10 mm
	10 320 2082	8 x 12 mm
	10 320 2085	11 x 16 mm
	10 320 2088	13 x 18 mm
	FEMALE THREAD	
	10 320 2232	G 1/4"
10 320 2234	G 3/8"	
10 320 2434	NPT 3/8"	

Icon	Part No.	Connection
	HOSE CONNECTION	
	10 320 5001	5 mm (3/16")
	10 320 5002	6.3 mm (1/4")
	10 320 5003	8 mm (5/16")
	10 320 5009	9 mm
	10 320 5004	10 mm (3/8")
	10 320 5005	13 mm (1/2")
	MALE THREAD	
	10 320 5151	R 1/8"
	10 320 5152	R 1/4"
	10 320 5154	R 3/8"
	10 320 5155	R 1/2"
	10 320 5263	G 1/4"
	10 320 5264	G 3/8"
	10 320 5265	G 1/2"
FEMALE THREAD		
10 320 5451	NPT 1/8"	
10 320 5452	NPT 1/4"	
10 320 5454	NPT 3/8"	
10 320 5455	NPT 1/2"	
10 320 5201	G 1/8"	
10 320 5202	G 1/4"	
10 320 5204	G 3/8"	
10 320 5205	G 1/2"	
10 320 5401	NPT 1/8"	
10 320 5402	NPT 1/4"	
10 320 5404	NPT 3/8"	
10 320 5405	NPT 1/2"	
STREAM-LINE CONNECTION		
10 320 5058	5 x 8 mm	
10 320 5060	6.5 x 10 mm	
10 320 5062	8 x 12 mm	
10 320 5063	9.5 x 13.5 mm	
10 320 5066	11 x 16 mm	
10 320 5068	13 x 18 mm	

CEJN reserves the right to make changes without further notification. Thread connections are listed according to ISO Standards. Other connections and sealing material on request. Check with an authorized CEJN distributor for availability and prices. Some part numbers may be subject to minimum order quantities. Please visit our website, www.cejn.com, for general maintenance tips.

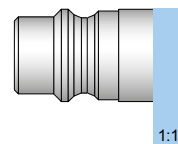

1:1

Series 326 – Standard

- **Handles tough environments**
- **One-hand operated**
- **Dust caps included as standard**

Compatible with aggressive medias, Series 326 stands up to food, offshore, and steam applications. Dust caps are included as standard. The Series 326 is interchangeable with all the versions of the Series 320.

The Series is also available in an all brass version (Series 324). Please refer to the CEJN Pneumatic range for specialized versions of the Series with nickel-plated steel/brass or aluminum constructions and as Vented Safety (Series 320).



TECHNICAL DATA

Nominal flow diameter	6,2 mm (1/4")
Air flow.....	725 l/min (25.6 CFM)
Max. working pressure.....	70 bar (1015 PSI)
Min. burst pressure.....	280 bar (4061 PSI)
Temperature range	-15°C – +100°C (5°F – +212°F)
Material coupling.....	Stainless steel (AISI 316)
Material nipple.....	Stainless steel (AISI 316)
Connection force.....	102 N
Markets.....	Global
Standards.....	CEJN Original, Eurostandard, 7.4 mm

AIR FLOW

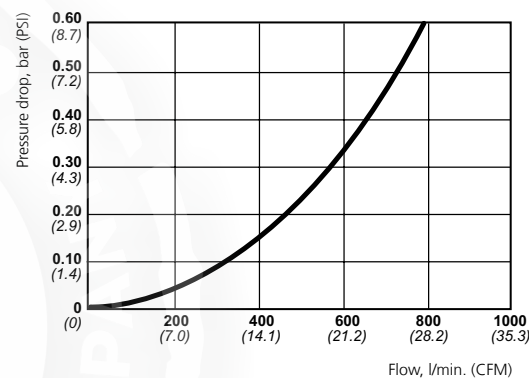

Flow capacity is measured at 6 bar (87 PSI) pressure drop.

COUPLINGS	FEMALE THREAD	Part No.	Connection
		10 326 1202	G 1/4"
		10 326 1205	G 1/2"
		10 326 1212	G 1/4"
		10 326 1204	G 3/8"
		10 326 1214	G 3/8"

NIPPLES	HOSE CONNECTION	Part No.	Connection
		10 326 5002	6.3 mm (1/4")
		10 326 5003	8 mm (5/16")
		10 326 5004	10 mm (3/8")
	MALE THREAD	10 326 5152	R 1/4"
		10 326 5154	R 3/8"
	FEMALE THREAD	10 326 5204	G 3/8"
		10 326 5205	G 1/2"
		10 326 5232	G 1/4"

CEJN reserves the right to make changes without further notification. Thread connections are listed according to ISO Standards. Other connections and sealing material on request. Check with an authorized CEJN distributor for availability and prices. Some part numbers may be subject to minimum order quantities. Please visit our website, www.cejn.com, for general maintenance tips.

1:1

Series 331 – Standard

- One-hand operated
- Strong and durable
- High-flow capacity

Series 331 couplings offer high-flow capacity and are insensitive to vibrations. One-hand operated with steel components for strength and durability.



TECHNICAL DATA

Nominal flow diameter	7 mm (9/32")
Air flow.....	1600 l/min (56.5 CFM)
Max. working pressure.....	16 bar (232 PSI)
Min. burst pressure.....	64 bar (928 PSI)
Temperature range	-30°C – +100°C (-22°F – +212°F)
Material coupling.....	Zinc-plated steel
Material nipple.....	Hardened zinc-plated steel
Connection force.....	65 N
Markets.....	Global
Standards.....	AC Q10, 7 mm

AIR FLOW

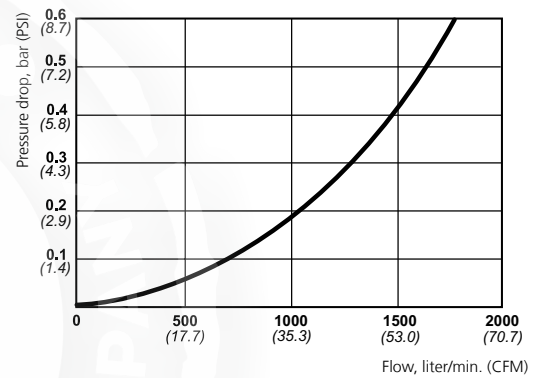

Flow capacity is measured at 6 bar (87 PSI) inlet pressure, and pressure drop at 0.5 bar (7 PSI)

COUPLINGS	HOSE CONNECTION	Part No.	Connection
		10 331 1002	6.3 mm (1/4")
		10 331 1003	8 mm (5/16")
		10 331 1004	10 mm (3/8")
		10 331 1005	13 mm (1/2")
	MALE THREAD	10 331 1152	R 1/4"
		10 331 1154	R 3/8"
		10 331 1155	R 1/2"
	FEMALE THREAD	10 331 1202	G 1/4"
		10 331 1204	G 3/8"
		10 331 1205	G 1/2"
		10 331 5152	R 1/4"
		10 331 5252	G 1/4"

NIPPLES	HOSE CONNECTION	Part No.	Connection
		10 331 5001	5 mm (3/16")
		10 331 5002	6.3 mm (1/4")
		10 331 5003	8 mm (5/16")
		10 331 5004	10 mm (3/8")
		10 331 5005	13 mm (1/2")
	MALE THREAD	10 331 5154	R 3/8"
		10 331 5155	R 1/2"
		10 331 5251	G 1/8"
	FEMALE THREAD	10 331 5254	G 3/8"
		10 331 5202	G 1/4"

CEJN reserves the right to make changes without further notification. Thread connections are listed according to ISO Standards. Other connections and sealing material on request. Check with an authorized CEJN distributor for availability and prices. Some part numbers may be subject to minimum order quantities. Please visit our website, www.cejn.com, for general maintenance tips.

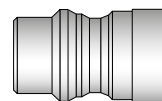

Series 342 – Safety Lock

- Automatic safety-locking feature
- Extremely high flow capacity
- One-hand operated

Series 342 couplings withstand extremely rough handling in extra tough applications. The Series features a zinc-plated steel construction with a locking sleeve made of hardened zinc-plated steel. The Series offers a wide range of connections, as well as anti-hose whip nipples. The automatic safety-locking feature prevents unintentional disconnection.

Please refer to the CEJN Breathing Air range for an all brass version (Series 341).



TECHNICAL DATA

Nominal flow diameter	7.4 mm (9/32")
Air flow	1950 l/min (68.8 CFM)
Max. working pressure	35 bar (507 PSI)
Min. burst pressure	140 bar (2030 PSI)
Temperature range	-30°C – +100°C (-22°F – +212°F)
Material coupling	Zinc-plated steel/brass
Material nipple	Hardened zinc-plated steel
Connection force	103 N
Markets	Global
Standards	CEJN Original, 7.4 mm, Safetylock

AIR FLOW

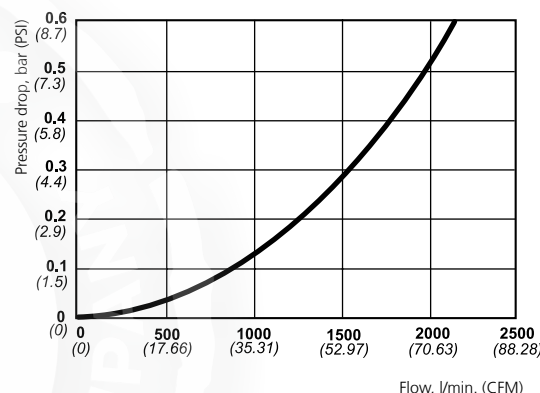

Flow capacity is measured at 6 bar (87 PSI) inlet pressure, and pressure drop at 0.5 bar (7 PSI).

COUPLINGS	HOSE CONNECTION	Part No.	Connection
		10 342 1002	6.3 mm (1/4")
		10 342 1003	8 mm (5/16")
		10 342 1004	10 mm (3/8")
		10 342 1005	13 mm (1/2")
	MALE THREAD	10 342 1152	R 1/4"
		10 342 1154	R 3/8"
		10 342 1155	R 1/2"
		10 342 1452	NPT 1/4"
		10 342 1454	NPT 3/8"
		10 342 1455	NPT 1/2"
	FEMALE THREAD	10 342 1202	G 1/4"
		10 342 1204	G 3/8"
		10 342 1205	G 1/2"
		10 342 1402	NPT 1/4"
		10 342 1404	NPT 3/8"
		10 342 1405	NPT 1/2"
	STREAM-LINE	10 342 1060	6.5 x 10 mm
		10 342 1062	8 x 12 mm

NIPPLES	HOSE CONNECTION	Part No.	Connection
		10 342 5002	6.3 mm (1/4")
		10 342 5004	10 mm (3/8")
		10 342 5005	13 mm (1/2")
	MALE THREAD	10 342 5152	R 1/4"
		10 342 5154	R 3/8"
		10 342 5155	R 1/2"
		10 342 5452	NPT 1/4"
		10 342 5454	NPT 3/8"
		10 342 5556	M16 x 1.5
	FEMALE THREAD	10 342 5202	G 1/4"
		10 342 5204	G 3/8"
		10 342 5205	G 1/2"
		10 342 5402	NPT 1/4"
	STREAM-LINE	10 342 5404	NPT 3/8"
		10 342 5060	6.5 x 10 mm
	10 342 5062	8 x 12 mm	

CEJN reserves the right to make changes without further notification. Thread connections are listed according to ISO Standards. Other connections and sealing material on request. Check with an authorized CEJN distributor for availability and prices. Some part numbers may be subject to minimum order quantities. Please visit our website, www.cejn.com, for general maintenance tips.

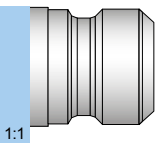

Series 408 – Standard

- Strong and durable
- One-hand operated
- Low connection force

Series 408 couplings offer high flow capacity and have higher resistance to vibrations than competitive couplings. The Series is suitable for vacuum service. A wide range of connections is available, as well as anti-hose whip nipples.



TECHNICAL DATA **AIR FLOW**

Nominal flow diameter 9.5 mm (3/8")
Air flow..... 3450 l/min (121.8 CFM)
Max. working pressure..... 16 bar (232 PSI)
Min. burst pressure..... 140 bar (2030 PSI)
Temperature range -20°C – +100°C (-4°F – +212°F)
Material coupling..... Zinc-plated steel/brass
Material nipple..... Hardened zinc-plated steel
Connection force..... 160 N
Markets..... Finland, Sweden
Standards..... Scandinavian Standard, 9.5 mm

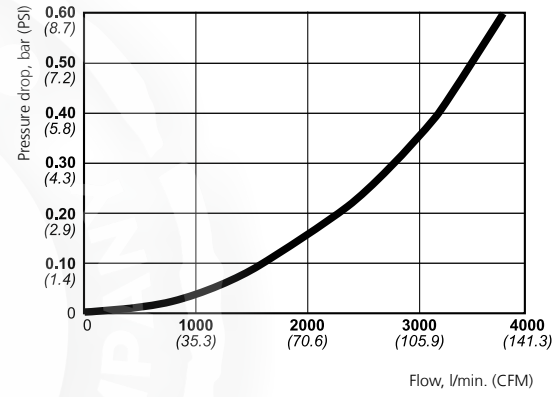

Flow capacity is measured at 6 bar (87 PSI) inlet pressure, and pressure drop at 0.5 bar (7 PSI).

COUPLINGS	Part No.	Connection
HOSE CONNECTION 	10 408 1003	8 mm (5/16")
	10 408 1004	10 mm (3/8")
	10 408 1005	13 mm (1/2")
	10 408 1006	16 mm (5/8")
	10 408 1007	19 mm (3/4")
MALE THREAD 	10 408 1154	R 3/8"
	10 408 1155	R 1/2"
	10 408 1157	R 3/4"
FEMALE THREAD 	10 408 1204	G 3/8"
	10 408 1205	G 1/2"
	10 408 1207	G 3/4"
STREAM-LINE CONNECTION 	10 408 1066	11x16 mm

NIPPLES	Part No.	Connection
HOSE CONNECTION 	10 408 5002	5 mm (1/4")
	10 408 5003	8 mm (5/16")
	10 408 5004	10 mm (3/8")
	10 408 5005	13 mm (1/2")
	10 408 5006	16 mm (5/8")
	10 408 5007	19 mm (3/4")
	MALE THREAD 	10 408 5152
10 408 5154		R 3/8"
10 408 5155		R 1/2"
10 408 5157		R 3/4"
FEMALE THREAD 	10 408 5202	G 1/4"
	10 408 5204	G 3/8"
	10 408 5205	G 1/2"
	10 408 5207	G 3/4"
STREAM-LINE CONNECTION 	10 408 5066	11x16 mm

CEJN reserves the right to make changes without further notification. Thread connections are listed according to ISO Standards. Other connections and sealing material on request. Check with an authorized CEJN distributor for availability and prices. Some part numbers may be subject to minimum order quantities. Please visit our website, www.cejn.com, for general maintenance tips.

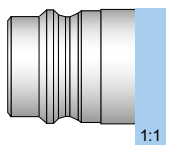

Series 410 – Standard

- **Extremely high flow capacity**
- **One-hand operated**
- **Strong and durable**

Series 410 couplings are an original CEJN design that has become a European standard. The Series is one-hand operated and offers long service life. A wide range of connections is available, as well as anti-hose whip nipples. The Series eSafe 410 version is disconnected in two stages in order to vent the coupling and minimize the risk of sudden component separation, which has the potential to cause operator injury. The one-hand operation ensures easy handling. The eSafe version complies with ISO Standard 4414 and EN 983 and has a steel front part as standard.

Series 410 is available in a standard and eSafe version. Please refer to the CEJN Fluid range for specialized versions of Series 410 with brass nipples (Series 411), high-pressure straight-through design (Series 412), two-way shutoff (Series 414), and stainless steel construction (Series 416).



TECHNICAL DATA **AIR FLOW**

Nominal flow diameter 10.4 mm (13/32")
Air flow..... 3900 l/min (137.7 CFM)
Max. working pressure..... 16 bar (232 PSI)
Min. burst pressure..... 140 bar (2030 PSI)
Temperature range -20°C – +100°C (-4°F – +212°F)
Material coupling..... Zinc-plated steel/brass
Material nipple..... Hardened zinc-plated steel
Connection force..... 105.2 N
Markets..... Global
Standards..... CEJN Original, Eurostandard 10.4mm

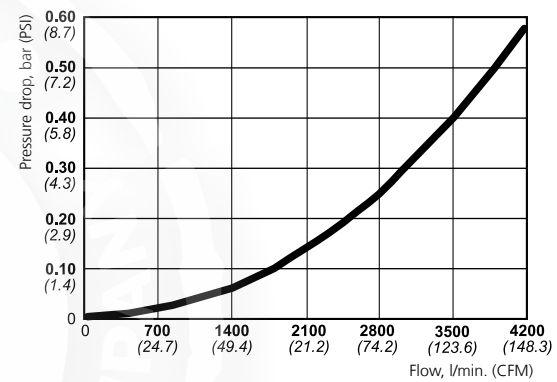

Flow capacity is measured at 6 bar (87 PSI) inlet pressure, and pressure drop at 0.5 bar (7 PSI).

	Part No.	Connection
COUPLINGS	HOSE CONNECTION	
		10 410 1003 8 mm (5/16")
		10 410 1004 10 mm (3/8")
		10 410 1005 13 mm (1/2")
		10 410 1006 16 mm (5/8")
		10 410 1007 19 mm (3/4")
	MALE THREAD	
		10 410 1154 R 3/8"
		10 410 1155 R 1/2"
		10 410 1157 R 3/4"
		10 410 1454 NPT 3/8"
		10 410 1455 NPT 1/2"
		10 410 1457 NPT 3/4"
	FEMALE THREAD	
		10 410 1204 G 3/8"
	10 410 1205 G 1/2"	
	10 410 1207 G 3/4"	
	10 410 1404 NPT 3/8"	
	10 410 1405 NPT 1/2"	
	10 410 1407 NPT 3/4"	
STREAM-LINE CONNECTION		
	10 410 1066 11x16 mm	
	10 410 1068	

	Part No.	Connection
NIPPLES	HOSE CONNECTION	
		10 410 5002 6.3 mm (1/4")
		10 410 5003 8 mm (5/16")
		10 410 5004 10 mm (3/8")
		10 410 5005 13 mm (1/2")
		10 410 5006 16 mm (5/8")
		10 410 5007 19 mm (3/4")
	MALE THREAD	
		10 410 5152 R 1/4"
		10 410 5154 R 3/8"
		10 410 5155 R 1/2"
		10 410 5157 R 3/4"
		10 410 5454 NPT 3/8"
		10 410 5455 NPT 1/2"
		10 410 5457 NPT 3/4"
FEMALE THREAD		
	10 410 5202 G 1/4"	
	10 410 5204 G 3/8"	
	10 410 5205 G 1/2"	
	10 410 5207 G 3/4"	
	10 410 5404 NPT 3/8"	
	10 410 5405 NPT 1/2"	
	10 410 5407 NPT 3/4"	
STREAM-LINE CONNECTION		
	10 410 5066 11 x 16 mm	
	10 410 5068 13 x 18 mm	

CEJN reserves the right to make changes without further notification. Thread connections are listed according to ISO Standards. Other connections and sealing material on request. Check with an authorized CEJN distributor for availability and prices. Some part numbers may be subject to minimum order quantities. Please visit our website, www.cejn.com, for general maintenance tips.

1:1

Series 410 – eSafe



- **Vented safety function**
- **Extremely high flow capacity**
- **Strong and durable**

eSafe Series 410 is a safety coupling based on CEJN Series 410, a CEJN original and European standard. The Series is one-hand operated and offers long service life. It is a one hand operated safety coupling that vents before disconnection eliminating the risk of hose whip. The fully automatic operation ensures quick and easy handling. It complies with ISO Standard 4414 and EN 983 and has a steel front part as standard.

Series 410 is also available as standard couplings.



TECHNICAL DATA

AIR FLOW

Nominal flow diameter 10.4 mm (13/32")
 Air flow 4000 l/min (141.2 CFM)
 Max. working pressure 16 bar (232 PSI)
 Min. burst pressure 140 bar (2030 PSI)
 Temperature range -20°C – +100°C (-4°F – +212°F)
 Material coupling Zinc-plated steel/brass
 Material nipple Hardened zinc-plated steel
 Connection force 140 N
 Markets Global
 Standards CEJN Original, Eurostandard 10.4 mm

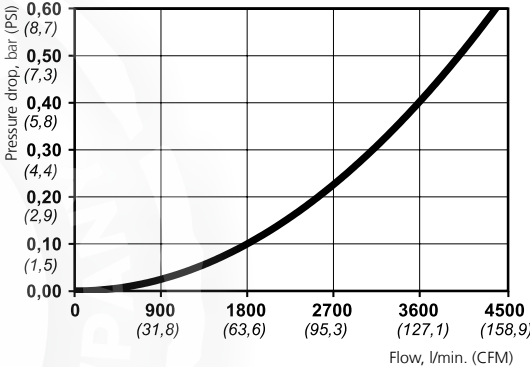

Flow capacity is measured at 6 bar (87 PSI) inlet pressure, and pressure drop at 0.5 bar (7 PSI).

Icon	Part No.	Connection
ESAFE VENTED SAFETY COUPLING 	HOSE CONNECTION	
	10 410 2003	8 mm (5/16")
	10 410 2004	10 mm (3/8")
	10 410 2005	13 mm (1/2")
	10 410 2006	16 mm (5/8")
10 410 2007	19 mm (3/4")	
MALE THREAD 	10 410 2154	R 3/8"
	10 410 2155	R 1/2"
	10 410 2157	R 3/4"
	10 410 2454	NPT 3/8"
	10 410 2455	NPT 1/2"
10 410 2457	NPT 3/4"	
FEMALE THREAD 	10 410 2204	G 3/8"
	10 410 2205	G 1/2"
	10 410 2207	G 3/4"
	10 410 2404	NPT 3/8"
	10 410 2405	NPT 1/2"
10 410 2407	NPT 3/4"	
STREAM-LINE CONNECTION 	10 410 2066	11 x 16 mm
	10 410 2068	13 x 18 mm

Icon	Part No.	Connection
NIPPLES 	HOSE CONNECTION	
	10 410 5002	6.3 mm (1/4")
	10 410 5003	8 mm (5/16")
	10 410 5004	10 mm (3/8")
	10 410 5005	13 mm (1/2")
	10 410 5006	16 mm (5/8")
	10 410 5007	19 mm (3/4")
MALE THREAD 	10 410 5152	R 1/4"
	10 410 5154	R 3/8"
	10 410 5155	R 1/2"
	10 410 5157	R 3/4"
	10 410 5454	NPT 3/8"
10 410 5455	NPT 1/2"	
10 410 5457	NPT 3/4"	
FEMALE THREAD 	10 410 5202	G 1/4"
	10 410 5204	G 3/8"
	10 410 5205	G 1/2"
	10 410 5207	G 3/4"
	10 410 5404	NPT 3/8"
10 410 5405	NPT 1/2"	
10 410 5407	NPT 3/4"	
STREAM-LINE CONNECTION 	10 410 5066	11 x 16 mm
	10 410 5068	13 x 18 mm

CEJN reserves the right to make changes without further notification. Thread connections are listed according to ISO Standards. Other connections and sealing material on request. Check with an authorized CEJN distributor for availability and prices. Some part numbers may be subject to minimum order quantities. Please visit our website, www.cejn.com, for general maintenance tips.

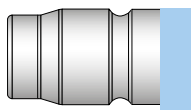

Series 421 – Standard

- One-hand operated
- Strong and durable
- High-flow capacity

Series 421 couplings offer high-flow capacity and are insensitive to vibrations. One-hand operated with steel components for strength and durability.







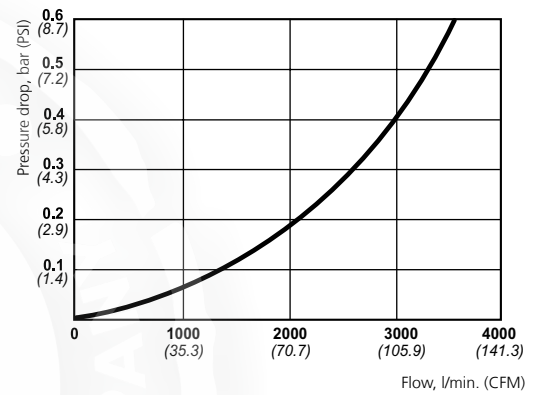

TECHNICAL DATA

Nominal flow diameter.....	10 mm (13/32"")
Air flow.....	3200 l/min (113.0 CFM)
Max. working pressure.....	16 bar (232 PSI)
Min. burst pressure.....	64 bar (928 PSI)
Temperature range.....	-30°C – +100°C (-22°F – +212°F)
Material coupling.....	Zinc-plated steel
Material nipple.....	Hardened zinc-plated steel
Connection force.....	160 N
Markets.....	Global
Standards.....	AC Q15, 10 mm

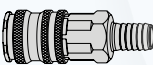
AIR FLOW

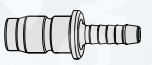

Flow capacity is measured at 6 bar (87 PSI) inlet pressure, and pressure drop at 0.5 bar (7 PSI)

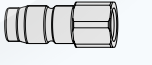
COUPLINGS				NIPPLES			
	HOSE CONNECTION	Part No.	Connection		HOSE CONNECTION	Part No.	Connection
		10 421 1004	10 mm (3/8")			10 421 5002	6.3 mm (1/4")
		10 421 1005	13 mm (1/2")			10 421 5003	8 mm (5/16")
		10 421 1006	16 mm (5/8")			10 421 5004	10 mm (3/8")
	MALE THREAD				MALE THREAD		
		10 421 1154	R 3/8"			10 421 5005	13 mm (1/2")
		10 421 1155	R 1/2"			10 421 5006	16 mm (5/8")
	FEMALE THREAD				FEMALE THREAD		
		10 421 1205	G 1/2"			10 421 5152	R 1/4"
						10 421 5154	R 3/8"
						10 421 5155	R 1/2"
						10 421 5254	G 3/8"
						10 421 5255	G 1/2"
						10 421 5202	G 1/4"
						10 421 5204	G 3/8"
						10 421 5205	G 1/2"

CEJN reserves the right to make changes without further notification. Thread connections are listed according to ISO Standards. Other connections and sealing material on request. Check with an authorized CEJN distributor for availability and prices. Some part numbers may be subject to minimum order quantities. Please visit our website, www.cejn.com, for general maintenance tips.

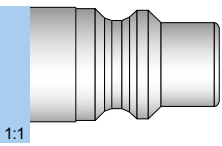

Series 430 – Standard

- Small outside dimensions
- High flow capacity
- One-hand operated

Series 430 couplings feature an easy-to-grip design and require only a low connection force. The Series offers a wide range of connections, as well as anti-hose whip nipples. The couplings have smaller outside dimensions than comparable designs.



TECHNICAL DATA

Nominal flow diameter.....	8.2 mm (5/16")
Air flow.....	2350 l/min (83.0 CFM)
Max. working pressure.....	16 bar (232 PSI)
Min. burst pressure.....	140 bar (2030 PSI)
Temperature range.....	-20°C – +100°C (-4°F – +212°F)
Material coupling.....	Zinc-plated steel/brass
Material nipple.....	Hardened zinc-plated steel
Connection force.....	110.8 N
Markets.....	France, North America, Norway
Standards.....	ISO 6150 B, A-A-59439, 8.2 mm

AIR FLOW

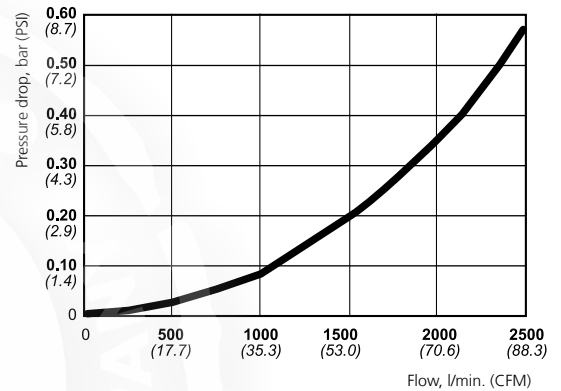

Flow capacity is measured at 6 bar (87 PSI) inlet pressure, and pressure drop at 0.5 bar (7 PSI).

COUPLINGS	HOSE CONNECTION	Part No.	Connection
		10 430 1003	8 mm (5/16")
		10 430 1004	10 mm (3/8")
		10 430 1005	13 mm (1/2")
		10 430 1006	16 mm (5/8")
		10 430 1007	19 mm (3/4")
	MALE THREAD	10 430 1154	R 3/8"
		10 430 1155	R 1/2"
		10 430 1157	R 3/4"
		10 430 1454	NPT 3/8"
		10 430 1455	NPT 1/2"
	FEMALE THREAD	10 430 1457	NPT 3/4"
		10 430 1204	G 3/8"
		10 430 1205	G 1/2"
		10 430 1207	G 3/4"
		10 430 1404	NPT 3/8"
	STREAM-LINE CONNECTION	10 430 1405	NPT 1/2"
		10 430 1407	NPT 3/4"
		10 430 1066	11x16 mm

NIPPLES	HOSE CONNECTION	Part No.	Connection
		10 430 5002	6.3 mm (1/4")
		10 430 5003	8 mm (5/16")
		10 430 5004	10 mm (3/8")
		10 430 5005	13 mm (1/2")
		10 430 5006	16 mm (5/8")
	MALE THREAD	10 430 5152	R 1/4"
		10 430 5154	R 3/8"
		10 430 5155	R 1/2"
		10 430 5157	R 3/4"
		10 430 5452	NPT 1/4"
	FEMALE THREAD	10 430 5454	NPT 3/8"
		10 430 5455	NPT 1/2"
		10 430 5457	NPT 3/4"
		10 430 5202	G 1/4"
		10 430 5204	G 3/8"
	STREAM-LINE CONNECTION	10 430 5205	G 1/2"
		10 430 5207	G 3/4"
		10 430 5402	NPT 1/4"
		10 430 5404	NPT 3/8"
		10 430 5405	NPT 1/2"
	10 430 5407	NPT 3/4"	
	10 430 5066	11x16 mm	

CEJN reserves the right to make changes without further notification. Thread connections are listed according to ISO Standards. Other connections and sealing material on request. Check with an authorized CEJN distributor for availability and prices. Some part numbers may be subject to minimum order quantities. Please visit our website, www.cejn.com, for general maintenance tips.

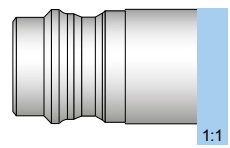

1:1

Series 442 – Safety Lock

- Automatic safety-locking feature
- Extremely high flow capacity
- One-hand operated

Series 442 couplings withstand extremely rough handling in extra tough applications. The series features a zinc-plated steel/brass construction with a locking sleeve made of hardened zinc-plated steel. The Series offers a wide range of connections, as well as anti-hose whip nipples. The automatic safety-locking feature prevents unintentional disconnection.

Please refer to the CEJN Breathing Air range for an all-brass version (Series 441).



TECHNICAL DATA

Nominal flow diameter	10.4 mm (13/32")
Air flow.....	3950 l/min (139.4 CFM)
Max. working pressure.....	35 bar (507 PSI)
Min. burst pressure.....	140 bar (2030 PSI)
Temperature range	-30°C – +100°C (-22°F – +212°F)
Material coupling.....	Zinc-plated steel/brass
Material nipple.....	Hardened zinc-plated steel
Connection force.....	169.6 N
Markets.....	Global
Standards.....	CEJN Original, 10.4 mm, Safetylock

AIR FLOW

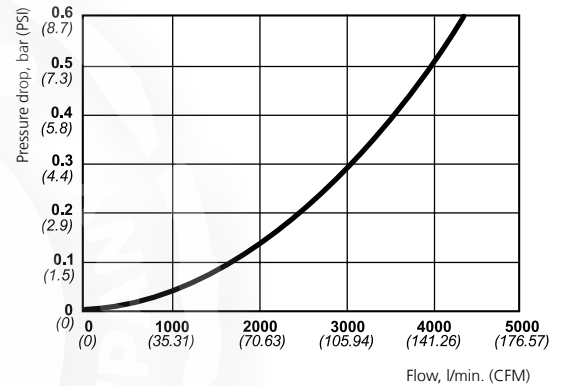

Flow capacity is measured at 6 bar (87 PSI) inlet pressure, and pressure drop at 0.5 bar (7 PSI).

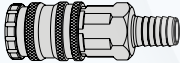
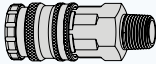
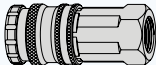
	Part No.	Connection
COUPLINGS 	HOSE CONNECTION	
	10 442 1003	8 mm (5/16")
	10 442 1004	10 mm (3/8")
	10 442 1005	13 mm (1/2")
	10 442 1006	16 mm (5/8")
	10 442 1007	19 mm (3/4")
	MALE THREAD	
	10 442 1154	R 3/8"
	10 442 1155	R 1/2"
	10 442 1157	R 3/4"
	FEMALE THREAD	
	10 442 1455	NPT 1/2"
	10 442 1457	NPT 3/4"
	10 442 1204	G 3/8"
	10 442 1205	G 1/2"
	10 442 1207	G 3/4"
	10 442 1404	NPT 3/8"
	10 442 1405	NPT 1/2"

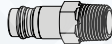
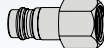
	Part No.	Connection
NIPPLES 	HOSE CONNECTION	
	10 442 5005	13 mm (1/2")
	10 442 5006	16 mm (5/8")
	MALE THREAD	
	10 442 5007	19 mm (3/4")
	FEMALE THREAD	
	10 442 5152	R 1/4"
	10 442 5154	R 3/8"
	10 442 5155	R 1/2"
	10 442 5157	R 3/4"
	10 442 5454	NPT 3/8"
	10 442 5455	NPT 1/2"
	10 442 5204	G 3/8"
	10 442 5205	G 1/2"
	10 442 5207	G 3/4"
10 442 5405	NPT 1/2"	

CEJN reserves the right to make changes without further notification. Thread connections are listed according to ISO Standards. Other connections and sealing material on request. Check with an authorized CEJN distributor for availability and prices. Some part numbers may be subject to minimum order quantities. Please visit our website, www.cejn.com, for general maintenance tips.

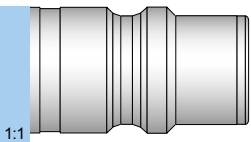

Series 550 – Standard

- Strong and durable
- Low connection force
- One-hand operated

Series 550 couplings feature an easy-to-grip design and require only a low connection force. They are smaller and more compact and generate higher flows than comparable designs. Series 550 couplings have an extremely low noise level upon disconnection. The Series includes anti-hose whip nipples.

The Series 550 eSafe is disconnected in two stages in order to vent the coupling and minimize the risk of sudden component separation, which has the potential to cause operator injury. The one-handed operation ensures easy handling. The eSafe version complies with ISO Standard 4414 and EN 983.

Series 550 is also available in a Vented Safety version.



TECHNICAL DATA **AIR FLOW**

Nominal flow diameter 11 mm (7/16")
Air flow..... 3750 l/min (132.4 CFM)
Max. working pressure..... 16 bar (232 PSI)
Min. burst pressure..... 140 bar (2030 PSI)
Temperature range -20°C – +100°C (-4°F – +212°F)
Material coupling..... Zinc-plated steel/brass
Material nipple..... Hardened zinc-plated steel
Connection force..... 145 N
Markets..... France, North America, Norway
Standards..... ISO 6150 B, A-A-59439, 11 mm

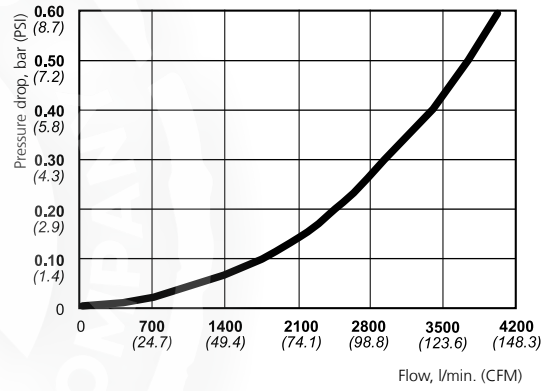

Flow capacity is measured at 6 bar (87 PSI) inlet pressure, and pressure drop at 0.5 bar (7 PSI)

COUPLINGS	HOSE CONNECTION	Part No.	Connection
		10 550 1004	10 mm (3/8")
		10 550 1005	13 mm (1/2")
		10 550 1007	19 mm (3/4")
	MALE THREAD	10 550 1154	R 3/8"
		10 550 1155	R 1/2"
		10 550 1157	R 3/4"
		10 550 1454	NPT 3/8"
		10 550 1455	NPT 1/2"
		10 550 1457	NPT 3/4"
	FEMALE THREAD	10 550 1204	G 3/8"
		10 550 1205	G 1/2"
		10 550 1207	G 3/4"
		10 550 1404	NPT 3/8"
		10 550 1405	NPT 1/2"
		10 550 1407	NPT 3/4"

NIPPLES	HOSE CONNECTION	Part No.	Connection	
		10 550 5004	10 mm (3/8")	
		10 550 5005	13 mm (1/2")	
		10 550 5007	19 mm (3/4")	
	MALE THREAD	10 550 5152	R 1/4"	
		10 550 5154	R 3/8"	
		10 550 5155	R 1/2"	
		10 550 5157	R 3/4"	
		10 550 5452	NPT 1/4"	
		10 550 5454	NPT 3/8"	
		10 550 5455	NPT 1/2"	
		10 550 5457	NPT 3/4"	
		FEMALE THREAD	10 550 5204	G 3/8"
			10 550 5205	G 1/2"
		10 550 5404	NPT 3/8"	
		10 550 5405	NPT 1/2"	
	10 550 5407	NPT 3/4"		

CEJN reserves the right to make changes without further notification. Thread connections are listed according to ISO Standards. Other connections and sealing material on request. Check with an authorized CEJN distributor for availability and prices. Some part numbers may be subject to minimum order quantities. Please visit our website, www.cejn.com, for general maintenance tips.

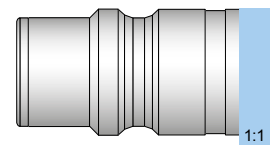

Series 550 – Vented Safety

- **Strong and durable**
- **Full automatic operation**
- **Extremely high-flow capacity**

Series 550 Vented Safety couplings feature an easy-to-grip design and require only a low connection force. They are smaller, more compact and generate higher flows than comparable designs. Series 550 couplings have an extremely low noise level upon disconnection. Anti-hose whip nipples are included in the series. The Vented Safety version disconnects in two stages in order to vent, minimize the risk of sudden component separation, reduce noise, and prevent recoil accidents. CEJN Vented Safety couplings are compliant with several international safety standards, e.g. ISO Standard 4414 and EN 983.

Series 550 Vented Safety is also available in a standard version.



TECHNICAL DATA

Nominal flow diameter	11 mm (7/16")
Air flow	3000 l/min (105.9 CFM)
Max. working pressure	16 bar (232 PSI)
Min. burst pressure	64 bar (928 PSI)
Connection force	68.6 N
Temperature range	20°C – +80°C (68°F – +176°F)
Material coupling	Zinc-plated steel/brass
Material nipple	Hardened zinc-plated steel
Standards	ISO 6150 B, A-A-59439, 11 mm

AIR FLOW

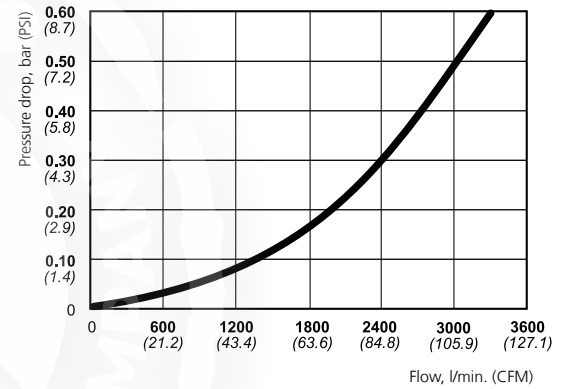

Flow capacity is measured at 6 bar (87 PSI) inlet pressure, and pressure drop at 0.5 bar (7 PSI).

COUPLINGS	MALE THREAD	Part No.	Connection
		10 550 3155	R 1/2"
		10 550 3157	R 3/4"
		10 550 3454	NPT 3/8"
		10 550 3457	NPT 3/4"
FEMALE THREAD		Part No.	Connection
		10 550 3205	G 1/2"
		10 550 3207	G 3/4"
		10 550 3404	NPT 3/8"
		10 550 3405	NPT 1/2"
		10 550 3407	NPT 3/4"

NIPPLES	HOSE CONNECTION	Part No.	Connection
		10 550 5004	10 mm (3/8")
		10 550 5005	13 mm (1/2")
		10 550 5007	19 mm (3/4")
MALE THREAD		Part No.	Connection
		10 550 5152	R 1/4"
		10 550 5154	R 3/8"
		10 550 5155	R 1/2"
		10 550 5157	R 3/4"
		10 550 5452	NPT 1/4"
		10 550 5454	NPT 3/8"
		10 550 5455	NPT 1/2"
FEMALE THREAD		Part No.	Connection
		10 550 5457	NPT 3/4"
		10 550 5204	G 3/8"
		10 550 5205	G 1/2"
		10 550 5404	NPT 3/8"
		10 550 5405	NPT 1/2"
	10 550 5407	NPT 3/4"	

CEJN reserves the right to make changes without further notification. Thread connections are listed according to ISO Standards. Other connections and sealing material on request. Check with an authorized CEJN distributor for availability and prices. Some part numbers may be subject to minimum order quantities. Please visit our website, www.cejn.com, for general maintenance tips.



Multi-Link System

– Flexible multiple outlet system saves time and space

The CEJN modular air distribution system delivers compressed air with no leakage and minimal pressure drop to the same high flow as the equivalent coupling series. Exact dimensioning and synchronized components, including couplings, hoses and FRL units ensure top-class performance. The units can also be connected with ease to create more access points - ideal for decluttering existing work areas or creating new flexible work stations. The integrated couplings provide flexibility and high performance, while the design allows for a large number of outlets without restricting the flow with T-connections, bends or elbows. Combined with our high-quality hose, they create a flexible, high-performance air distribution system.

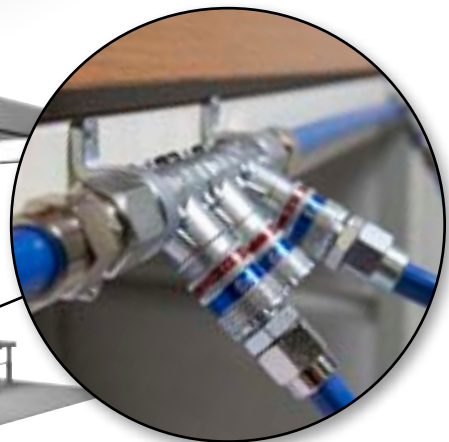

The Multi-Link unit can rotate to give a flexible work station.

Multi-Link Systems

The Multi-Link integrated quick connect couplings come in units of 1 to 5 outlets.

TECHNICAL DATA

Temperature range: -20°C – 100°C (-4°F – 212°F)

Max. working pressure:..... 16 bar (230 PSI)

Material: Zinc-plated steel/zinc



		Part No.	Connection
SERIES 310	2-outlet unit	19 902 9922	G 1/2"
	3-outlet unit	19 902 9923	G 1/2"

		Part No.	Connection
SERIES 315	2-outlet unit	19 902 9972	G 1/2"
	3-outlet unit	19 902 9973	G 1/2"
	4-outlet unit	19 902 9974	G 1/2"
	5-outlet unit	19 902 9975	G 1/2"

		Part No.	Connection
SERIES 320	2-outlet unit	19 902 9912	G 1/2"
	3-outlet unit	19 902 9913	G 1/2"

		Part No.	Connection
FEMALE ADAPTER	Extension unit G 1/2"	19 902 9990	G 1/2"
	1-outlet unit G 1/2"	19 902 9991	G 1/2"
	2-outlet unit G 1/2"	19 902 9992	G 1/2"
	3-outlet unit G 1/2"	19 902 9993	G 1/2"
	4-outlet unit G 1/2"	19 902 9994	G 1/2"

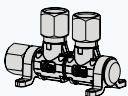

		Part No.	Connection
SERIE 300 ESAFE	Extension unit	19 902 9000	G 1/2"
	1-outlet unit	19 902 9001	G 1/2"
	2-outlet unit	19 902 9002	G 1/2"
	3-outlet unit	19 902 9003	G 1/2"
	4-outlet unit	19 902 9004	G 1/2"

		Part No.	Connection
SERIE 310 ESAFE	Extension unit	19 902 9100	G 1/2"
	1-outlet unit	19 902 9101	G 1/2"
	2-outlet unit	19 902 9102	G 1/2"
	3-outlet unit	19 902 9103	G 1/2"
	4-outlet unit	19 902 9104	G 1/2"

		Part No.	Connection
SERIE 315 ESAFE	Extension unit	19 902 9150	G 1/2"
	1-outlet unit	19 902 9151	G 1/2"
	2-outlet unit	19 902 9152	G 1/2"
	3-outlet unit	19 902 9153	G 1/2"
	4-outlet unit	19 902 9154	G 1/2"

		Part No.	Connection
SERIE 320 ESAFE	Extension unit	19 902 9200	G 1/2"
	1-outlet unit	19 902 9201	G 1/2"
	2-outlet unit	19 902 9202	G 1/2"
	3-outlet unit	19 902 9203	G 1/2"
	4-outlet unit	19 902 9204	G 1/2"
	5-outlet unit	19 902 9205	G 1/2"

CEJN reserves the right to make changes without further notification. Thread connections are listed according to ISO Standards. Other connections and sealing material on request.

Check with an authorized CEJN distributor for availability and prices. Some part numbers may be subject to minimum order quantities. Please visit our website, www.cejn.com, for general maintenance tips.



Stream-Line Hose

– For leak-free systems and longer life span

CEJN Hose are lightweight and extremely flexible and have excellent recoilability, making them a perfect mate for small and lightweight pneumatic tools. They are abrasion-resistant and score high marks in terms of impact, tensile and tear strength and lasts up to 10 times longer than conventional PVC hose.

CEJN's Stream-Line Series is a range of PUR hoses that is compatible with the other Stream-Line products, such as couplings, kink protectors and adapters, just to reduce the risk of leakage and give the customer's pneumatic system a higher quality and longer life span. The Stream-Line seal is made of a cone and swivel nut and, together with the stream-line hose, you get a tight and secure joint without clamps. The seal does not require any retightening.



Straight Hose – Braided

- **Light and flexible**
- **Excellent resistance to oil, solvents, and other non-aqueous solutions**
- **Long service life with outstanding aging qualities**

CEJN straight braided hose is an excellent choice for applications requiring a maximum working pressure up to 16 bar (232 PSI). It offers a wide temperature range and high tensile, tear, and impact strength. The hose easily springs back to its original form and has excellent abrasion resistance.

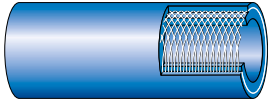

Size ID x OD

- 6.5 x 10 mm
- 8 x 12 mm
- 9.5 x 13.5 mm
- 11 x 16 mm
- 13 x 18 mm

Hose material Ester-based polyurethane reinforced with polyester fiber

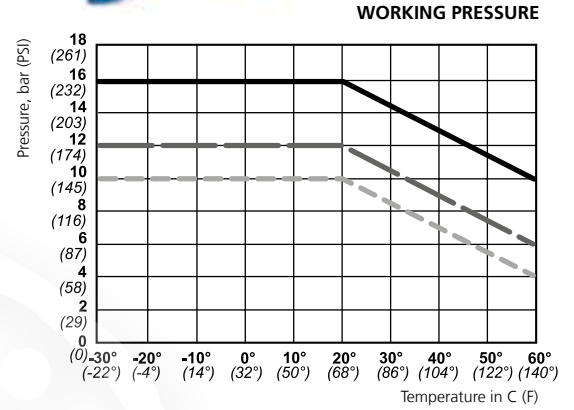

	ID x OD	Total length	Part No.	Max working pressure (20°C, 68°F)	Burst pressure (20°C, 68°F)
STRAIGHT BRAIDED	6.5 x 10 mm	100 m	19 958 1000	16 bar (232 PSI)	64 bar (928 PSI)
		50 m	19 958 1020	16 bar (232 PSI)	64 bar (928 PSI)
	8 x 12 mm	100 m	19 958 1200	16 bar (232 PSI)	64 bar (928 PSI)
		50 m	19 958 1220	16 bar (232 PSI)	64 bar (928 PSI)
	9.5 x 13.5 mm	100 m	19 958 1350	16 bar (232 PSI)	64 bar (928 PSI)
		50 m	19 958 1370	16 bar (232 PSI)	64 bar (928 PSI)
	11 x 16 mm	100 m	19 958 1600	12 bar (174 PSI)	48 bar (696 PSI)
		50 m	19 958 1638	12 bar (174 PSI)	48 bar (696 PSI)
	13 x 18 mm	50 m	19 958 1801	10 bar (145 PSI)	40 bar (580 PSI)

Straight Hose – Non-Braided

- **Suitable for push-to-connect fittings**
- **Excellent resistance to oils, solvents, and other non-aqueous solutions**
- **Long service life with outstanding aging qualities**

CEJN non-braided hose is an excellent choice for applications requiring a maximum working pressure up to 10 bar (145 PSI). It is light and flexible and offers high tensile, tear, and impact strength. The hose easily springs back to its original form.



Size ID x OD

- 4 x 6 mm
- 5 x 8 mm
- 6.5 x 10 mm
- 8 x 12 mm
- 11 x 16 mm

Hose material FDA approved, Ester-based polyurethane

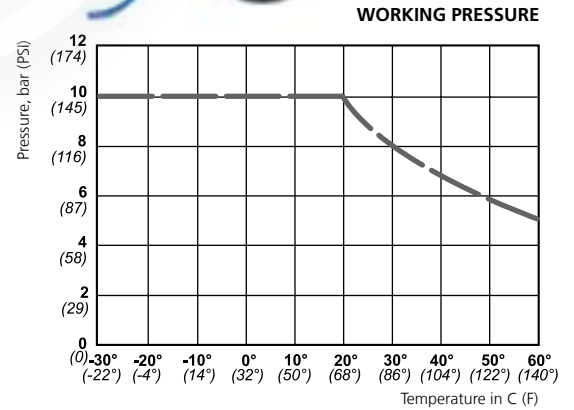

	ID x OD	Total length	Part No.	Max working pressure (20°C, 68°F)	Burst pressure (20°C, 68°F)
NON-BRAIDED STRAIGHT HOSE	4 x 6 mm	50 m	19 958 0702	10 bar (145 PSI)	25 bar (362 PSI)
	5 x 8 mm	50 m	19 958 0802	10 bar (145 PSI)	25 bar (362 PSI)
	6.5 x 10 mm	50 m	19 958 1002	10 bar (145 PSI)	25 bar (362 PSI)
	8 x 12 mm	50 m	19 958 1202	10 bar (145 PSI)	25 bar (362 PSI)
	11 x 16 mm	50 m	19 958 1602	10 bar (145 PSI)	25 bar (362 PSI)

CEJN reserves the right to make changes without further notification. Thread connections are listed according to ISO Standards. Other connections and sealing material on request. Check with an authorized CEJN distributor for availability and prices. Some part numbers may be subject to minimum order quantities. Please visit our website, www.cejn.com, for general maintenance tips.

Antistatic Hose – Straight Braided

- **Dissipates electro-static discharge**
- **Excellent weather resistance**
- **Extreme flexibility**

The electrically conductive hose is made of braided EPDM Rubber that dissipates electro-static discharge and minimizes errant sparks. It is an excellent choice for applications in which media causes excessive static charge or where a static discharge has the potential to cause explosion or damage. The hose offers extreme flexibility in all weather and has a protective cover that stands up well to the elements.

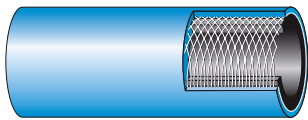

Size ID x OD

- 8 x 15 mm
- 10 x 17.5 mm
- 12 x 19.5 mm

Hose material..... Braided EPDM Rubber

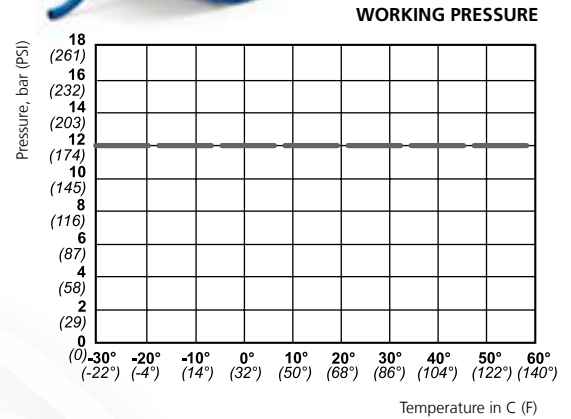

	ID x OD	Total length	Part No.	Max working pressure (20°C, 68°F)	Burst pressure (20°C, 68°F)
ELECTRICALLY CONDUCTIVE HOSE	8 x 15 mm	40 m	19 900 9920	12 bar (174 PSI)	48 bar (696 PSI)
	10 x 17,5 mm	40 m	19 900 9918	12 bar (174 PSI)	48 bar (696 PSI)
	12 x 19.5 mm	40 m	19 900 9921	12 bar (174 PSI)	48 bar (696 PSI)

Anti-Spark Hose – Straight Braided

- **Spark and scorch resistant**
- **Excellent resistance to oils, solvents, and other non-aqueous solutions**
- **Long service life with outstanding aging qualities**

CEJN anti-spark hose is resistant to scorching and damage due to exposure to sparks that are present in welding environments or where cutting equipment is in use. The hose offers outstanding aging qualities and long duty. It is light and flexible and has high impact strength, as well as high tensile and tear strength. The hose easily springs back to its original form.

The first layer of the hose consists of ester-based polyurethane, the second of polyester fiber braiding and the third of ester-based polyurethane.

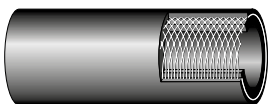

Size ID x OD

- 8 x 12 mm
- 9.5 x 13.5 mm
- 11 x 16 mm

Hose material..... Ester-based polyurethane reinforced with polyester fiber

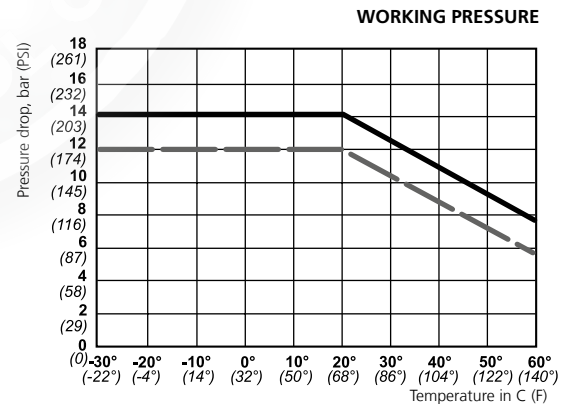

	ID x OD	Total length	Part No.	Max working pressure (20°C, 68°F)	Burst pressure (20°C, 68°F)
STRAIGHT BRAIDED HOSE	8 x 12 mm	50 m	19 958 1230	14 bar (203 PSI)	56 bar (812 PSI)
	9.5 x 13.5 mm	50 m	19 958 1330	12 bar (174 PSI)	48 bar (696 PSI)
	11 x 16 mm	50 m	19 958 1637	12 bar (174 PSI)	48 bar (696 PSI)

CEJN reserves the right to make changes without further notification. Thread connections are listed according to ISO Standards. Other connections and sealing material on request. Check with an authorized CEJN distributor for availability and prices. Some part numbers may be subject to minimum order quantities. Please visit our website, www.cejn.com, for general maintenance tips.

Water Hose – Straight Braided

- **Light and flexible**
- **Excellent resistance to oils, solvents, and both aqueous and non-aqueous solutions**
- **Long service life with outstanding aging qualities**

CEJN water hose is designed to be used with water but is also an excellent choice for compressed air in damp and wet environments. It has high impact strength and is functional in a wide temperature range. The hose easily springs back to its original form and has excellent abrasion resistance. The first layer of the hose consists of ether-based polyurethane, the second of polyester fiber and the third of ether-based polyurethane.

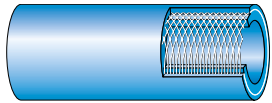

Size ID x OD

- 8 x 12 mm
- 11 x 16 mm

Hose material Ether-based PUR reinforced with polyester fiber

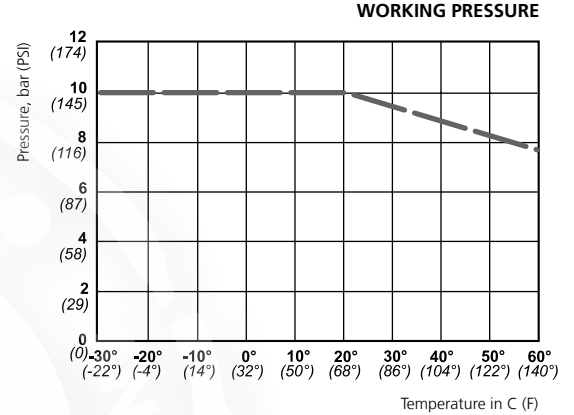

	ID x OD	Total length	Part No.	Max working pressure (20°C, 68°F)	Burst pressure (20°C, 68°F)
STRAIGHT BRAIDED	8 x 12 mm	50 m	19 958 1240	10 bar (145 PSI)	40 bar (580 PSI)
	11 x 16 mm	50 m	19 958 1640	10 bar (145 PSI)	40 bar (580 PSI)

CEJN reserves the right to make changes without further notification. Thread connections are listed according to ISO Standards. Other connections and sealing material on request. Check with an authorized CEJN distributor for availability and prices. Some part numbers may be subject to minimum order quantities. Please visit our website, www.cejn.com, for general maintenance tips.



Spiral Hose – Non-Braided

- **Light and flexible**
- **Excellent resistance to oils, solvents, and both aqueous and non-aqueous solutions**
- **Long service life with outstanding aging qualities**

CEJN spiral hose is an excellent choice for applications that call for hose to have excellent recoil ability and crimp resistance. It offers high tensile and tear strength and resistance to impacts. The hose is abrasion resistant and is suitable for applications in a wide temperature range.

Max. working pressure..... 10 bar (145 PSI) (20°C, 68°F)
Min. burst pressure..... 25 bar (362 PSI) (20°C, 68°F)
Hose material..... FDA approved, Ester-based polyurethane

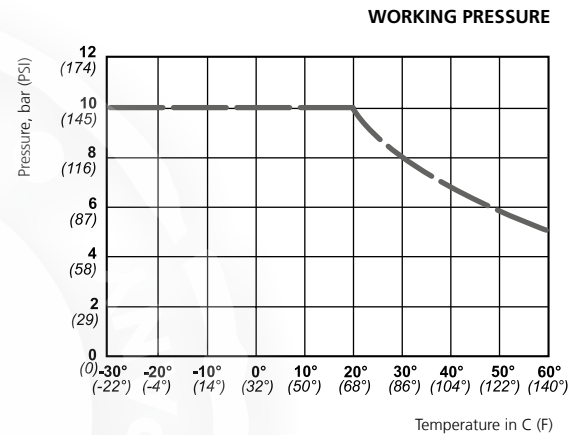
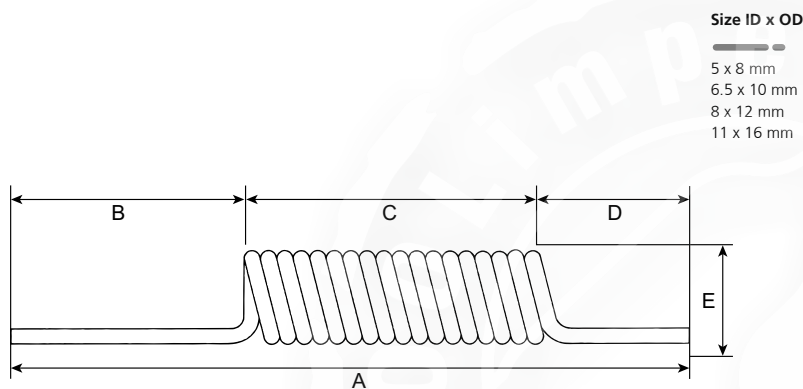

SERVICE LENGTH	ID x OD	Total length	Part No.	A	B	C	D	E
2 METERS	5 x 8 mm	2.5 m	19 958 5820	740	500	140	100	42
	6.5 x 10 mm	2.5 m	19 958 6020	740	500	140	100	52
	8 x 12 mm	2.5 m	19 958 6220	740	500	140	100	65
	11 x 16 mm	2.5 m	19 958 6620	720	500	120	100	95
4 METERS	5 x 8 mm	5.0 m	19 958 5840	930	500	330	100	42
	6.5 x 10 mm	5.0 m	19 958 6040	930	500	330	100	52
	8 x 12 mm	5.0 m	19 958 6240	920	500	320	100	65
	11 x 16 mm	5.0 m	19 958 6640	880	500	280	100	95
6 METERS	5 x 8 mm	7.5 m	19 958 5860	1120	500	520	100	42
	6.5 x 10 mm	7.5 m	19 958 6060	1120	500	520	100	52
	8 x 12 mm	7.5 m	19 958 6260	1100	500	500	100	65
	11 x 16 mm	7.5 m	19 958 6660	1040	500	440	100	95
8 METERS	5 x 8 mm	10.0 m	19 958 5880	1300	500	700	100	42
	6.5 x 10 mm	10.0 m	19 958 6080	1310	500	710	100	52
	8 x 12 mm	10.0 m	19 958 6280	1280	500	680	100	65
	11 x 16 mm	10.0 m	19 958 6680	1210	500	610	100	95

Spiral Anti-Spark Hose – Non-Braided

- **Spark and scorch resistant**
- **Excellent resistance to oils, solvents, and other non-aqueous solutions**
- **Long service life with outstanding aging qualities**

CEJN spiral anti-spark hose is resistant to scorching and damage due to exposure to sparks that are present in welding environments or where cutting equipment is in use. Its excellent recoil ability and outstanding aging qualities make it ideal for assembly lines and fixed workplaces. The hose can also be used for breathing air applications.

See the *CEJN Breathing Air Product Range* for more information.



Max. working pressure..... 10 bar (145 PSI) (20°C, 68°F)
Min. burst pressure..... 25 bar (362 PSI) (20°C, 68°F)
Hose material Ester-based polyurethane

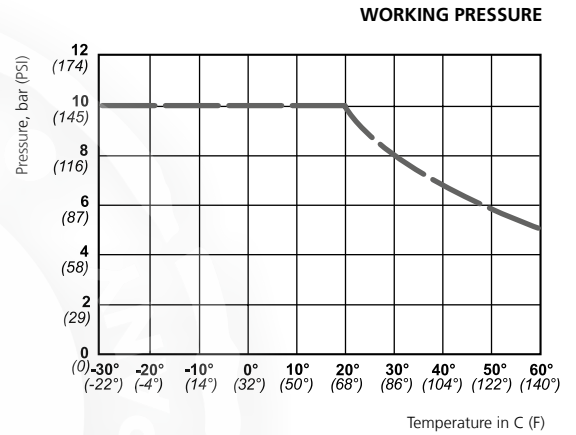
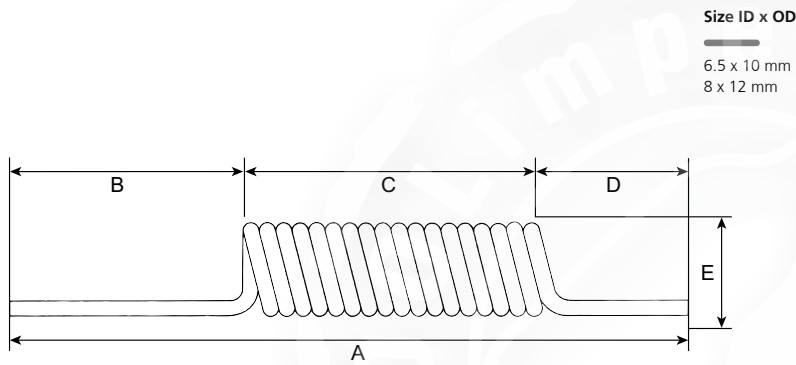

SERVICE LENGTH	ID x OD	Total length	Part No.	A	B	C	D	E
2 M	6.5 x 10 mm	2.5 m	19 958 4020	740	500	140	100	52
	8 x 12 mm	2.5 m	19 958 4220	740	500	140	100	65
4 M	6.5 x 10 mm	5.0 m	19 958 4040	930	500	330	100	52
	8 x 12 mm	5.0 m	19 958 4240	920	500	320	100	65
6 M	6.5 x 10 mm	7.5 m	19 958 4060	1120	500	520	100	52
	8 x 12 mm	7.5 m	19 958 4260	1100	500	500	100	65
8 M	6.5 x 10 mm	8.0 m	19 958 4080	1310	500	710	100	52
	8 x 12 mm	8.0 m	19 958 4280	1280	500	680	100	65

CEJN reserves the right to make changes without further notification. Thread connections are listed according to ISO Standards. Other connections and sealing material on request. Check with an authorized CEJN distributor for availability and prices. Some part numbers may be subject to minimum order quantities. Please visit our website, www.cejn.com, for general maintenance tips.



Stream-Line Hose Kits

– Pre-assembled hose and coupling combinations for immediate use

CEJN Stream-Line Hose Kits provide an easy, convenient means of obtaining just the right hose and coupling combinations for pneumatic applications. Each kit contains a CEJN Stream-Line polyurethane hose, Stream-Line couplings, nipples and swivels that provide reusable, leak-free hose connections.

The hose kit is ready for immediate use without the need for tools, and customers are assured of no missing parts. Kit contents are reusable and air-tight and won't need follow-up tightening. The hose kit concept also simplifies ordering procedures, since only one part number is required to order multiple products.

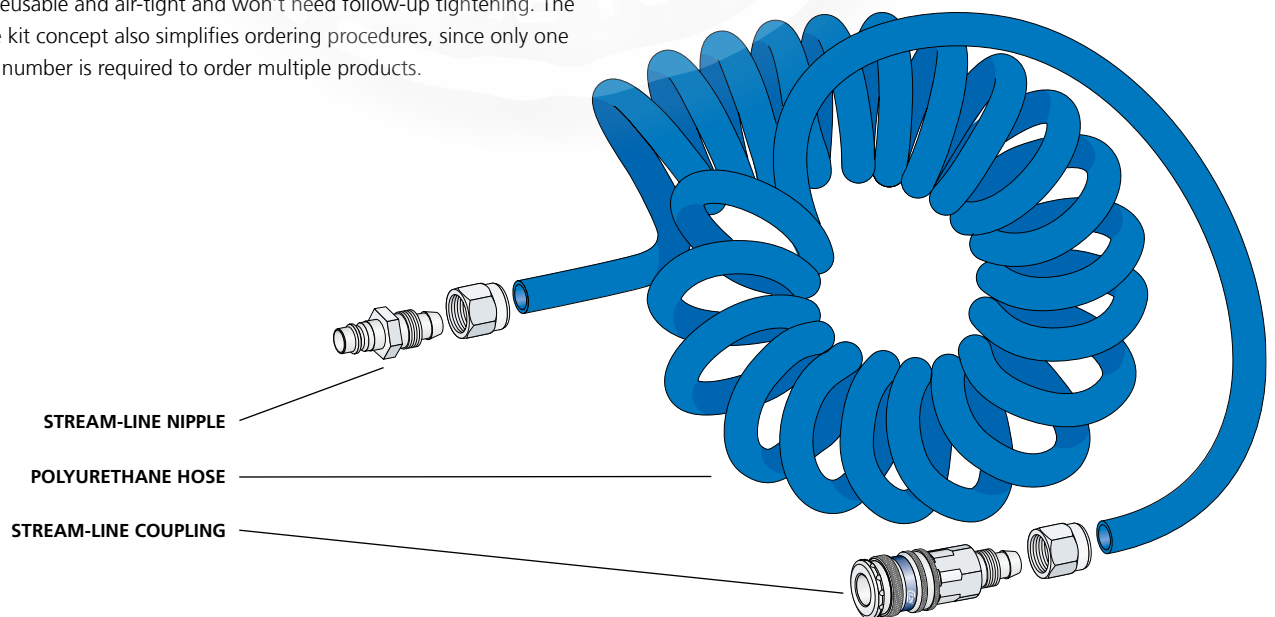

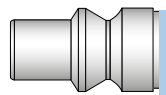

PUR Hose Kits – with Series 300

ARO 210 Standard

- Series 300 couplings and nipples
- Flexible PUR hose with long service life
- Pre-assembled and ready to use

CEJN Hose Kits come pre-assembled and ready for immediate use. They consist of an extremely flexible, straight braided or spiral polyurethane (PUR) hose combined with Series 300 Standard or Vented Safety couplings and nipples with reusable Stream-Line connections.

PUR Hose Kits are also available with Series 310, 320 and 410 Standard or Vented Safety couplings and nipples.



Flow capacity is measured at 6 bar (87 PSI) inlet pressure, and pressure drop at 0.5 bar (7 PSI).

		Service length	Part No.	ID x OD	Max working pressure
SERIES 300	Spiral	2.0 m	19 958 9977	5x8 mm	10 bar (145 PSI)
		4.0 m	19 958 9948	6.5x10 mm	10 bar (145 PSI)
		6.0 m	19 958 9952	6.5x10 mm	10 bar (145 PSI)
	Straight Braided	10.0 m	19 958 9802	8x12 mm	16 bar (232 PSI)
		15.0 m	19 958 9842	8x12 mm	16 bar (232 PSI)
SERIES 300, ESAFE	Spiral	2.0 m	19 958 9739	6.5x10 mm	10 bar (145 PSI)
		4.0 m	19 958 9330	8x12 mm	10 bar (145 PSI)
			19 958 9740	6.5x10 mm	10 bar (145 PSI)
			19 958 9712	8x12 mm	10 bar (145 PSI)
		6.0 m	19 958 9345	11x16 mm	10 bar (145 PSI)
	19 958 9741		6.5x10 mm	10 bar (145 PSI)	
	19 958 9713		8x12 mm	10 bar (145 PSI)	
	8.0 m	19 958 9742	6.5x10 mm	10 bar (145 PSI)	
		19 958 9714	8x12 mm	10 bar (145 PSI)	
	Straight Braided	10.0 m	19 958 9782	11 x 16 mm	10 bar (145 PSI)
			19 958 9704	8x12 mm	16 bar (232 PSI)
15.0 m		19 958 9705	8x12 mm	16 bar (232 PSI)	
10.0 m		19 958 9335	9.5x13.5 mm	10 bar (145 PSI)	
15.0 m		19 958 9336	9.5x13.5 mm	10 bar (145 PSI)	



CEJN reserves the right to make changes without further notification. Thread connections are listed according to ISO Standards. Other connections and sealing material on request. Check with an authorized CEJN distributor for availability and prices. Some part numbers may be subject to minimum order quantities. Please visit our website, www.cejn.com, for general maintenance tips.

AIR FLOW

- HOSE 5X8 MM
- HOSE 6.5X10 MM
- HOSE 8X12 MM
- HOSE 9.5X13.5 MM
- HOSE 11X16 MM

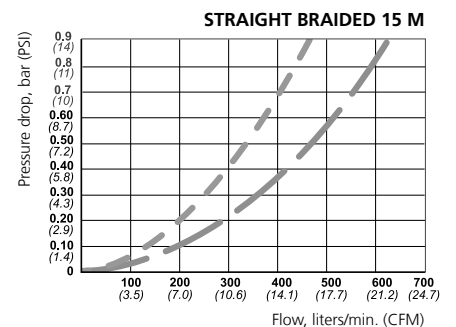
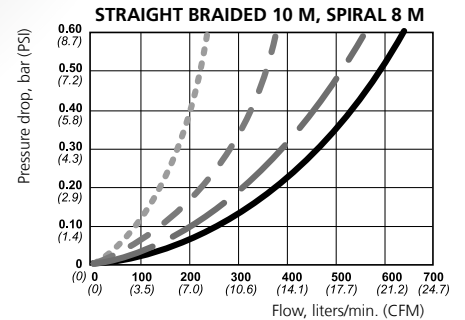
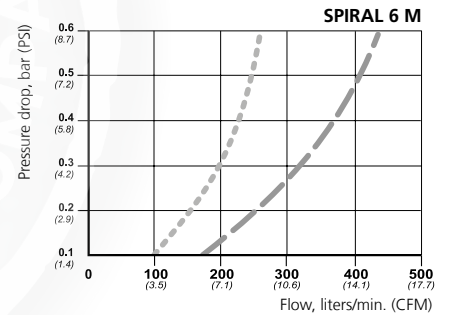
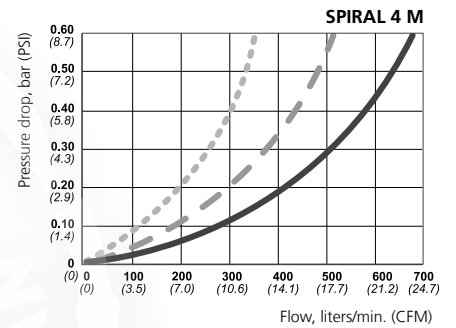
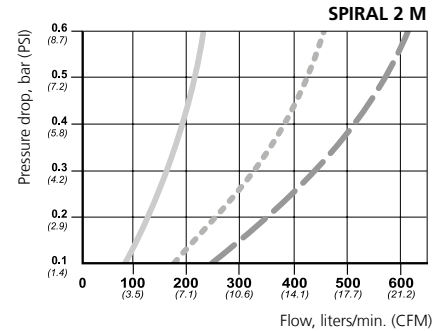

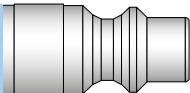

1:1

PUR Hose Kits – with Series 310

ISO 6150 B, A-A 59439

- **Series 310 couplings and nipples**
- **Flexible PUR hose with long service life**
- **Pre-assembled and ready to use**

CEJN Hose Kits come pre-assembled and ready for immediate use. They consist of an extremely flexible, straight braided or spiral polyurethane (PUR) hose combined with Series 310 Standard or eSafe couplings and nipples with reusable Stream-Line connections.

PUR Hose Kits are also available with Series 300, 320 and 410 Standard or Vented Safety couplings and nipples.



Flow capacity is measured at 6 bar (87 PSI) inlet pressure, and pressure drop at 0.5 bar (7 PSI).

		Service length	Part No.	ID x OD	Max working pressure
SERIES 310	Spiral	2.0 m	19 958 9923	5 x 8 mm	10 bar (145 PSI)
			19 958 9927	6.5 x 10 mm	10 bar (145 PSI)
			19 958 9931	8 x 12 mm	10 bar (145 PSI)
		4.0 m	19 958 9928	6.5 x 10 mm	10 bar (145 PSI)
			19 958 9932	8 x 12 mm	10 bar (145 PSI)
			19 958 9936	11 x 16 mm	10 bar (145 PSI)
	6.0 m	19 958 9929	6.5 x 10 mm	10 bar (145 PSI)	
		19 958 9933	8 x 12 mm	10 bar (145 PSI)	
		8.0 m	19 958 9930	6.5 x 10 mm	10 bar (145 PSI)
	19 958 9934		8 x 12 mm	10 bar (145 PSI)	
	Straight Braided		10.0 m	19 958 9832	8 x 12 mm
		19 958 9337		9.5 x 13.5 mm	16 bar (232 PSI)
19 958 9833		8 x 12 mm		16 bar (232 PSI)	
15.0 m	19 958 9338	9.5 x 13.5 mm	16 bar (232 PSI)		
	SERIES 310, ESAFE	Spiral	19 958 9331	8 x 12 mm	10 bar (145 PSI)
			19 958 9709	8 x 12 mm	10 bar (145 PSI)
19 958 9710			8 x 12 mm	10 bar (145 PSI)	
Straight Braided		19 958 9711	8 x 12 mm	10 bar (145 PSI)	
		10.0 m	19 958 9701	8 x 12 mm	16 bar (232 PSI)
		15.0 m	19 958 9702	8 x 12 mm	16 bar (232 PSI)



CEJN reserves the right to make changes without further notification. Thread connections are listed according to ISO Standards. Other connections and sealing material on request. Check with an authorized CEJN distributor for availability and prices. Some part numbers may be subject to minimum order quantities. Please visit our website, www.cejn.com, for general maintenance tips.

AIR FLOW

- HOSE 5X8 MM
- HOSE 6.5X10 MM
- HOSE 8X12 MM
- HOSE 9.5X13.5 MM
- HOSE 11X16 MM

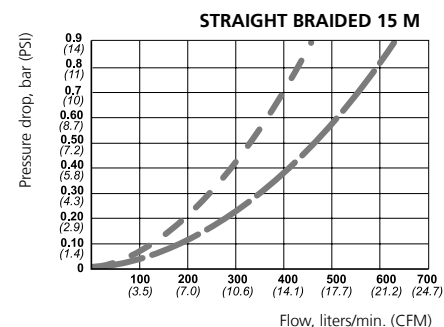
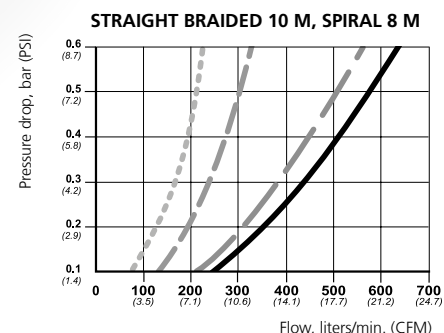
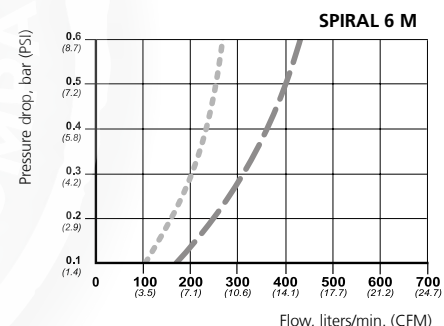
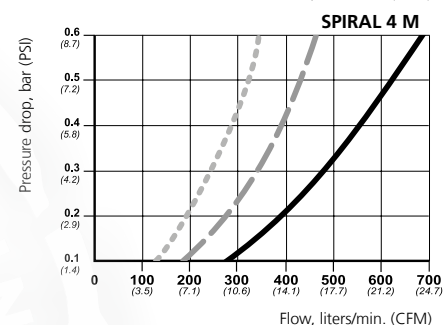
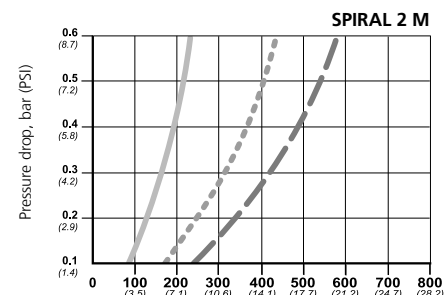

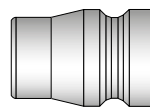

PUR Hose Kits – with Series 315

Asian Standard, 7.5 mm

- Series 315 couplings and nipples
- Flexible PUR hose with long service life
- Pre-assembled and ready to use

CEJN Hose Kits come pre-assembled and ready for immediate use. They consist of an extremely flexible, straight braided or spiral polyurethane (PUR) hose combined with Series 315 Standard oreSafe couplings and nipples with reusable Stream-Line connections.



Flow capacity is measured at 6 bar (87 PSI) inlet pressure, and pressure drop at 0.5 bar (7 PSI).

		Service length	Part No.	ID x OD	Max working pressure	
SERIES 315	Spiral	2.0 m	19 958 9410	5 x 8 mm	10 bar (145 PSI)	
			19 958 9414	6.5 x 10 mm	10 bar (145 PSI)	
			19 958 9418	8 x 12 mm	10 bar (145 PSI)	
		4.0 m	19 958 9422	11 x 16 mm	10 bar (145 PSI)	
			19 958 9411	5 x 8 mm	10 bar (145 PSI)	
			19 958 9415	6.5 x 10 mm	10 bar (145 PSI)	
		6.0 m	19 958 9419	8 x 12 mm	10 bar (145 PSI)	
			19 958 9423	11 x 16 mm	10 bar (145 PSI)	
			19 958 9412	5 x 8 mm	10 bar (145 PSI)	
		8.0 m	19 958 9416	6.5 x 10 mm	10 bar (145 PSI)	
			19 958 9420	8 x 12 mm	10 bar (145 PSI)	
			19 958 9424	11 x 16 mm	10 bar (145 PSI)	
		Straight Braided	10 m	19 958 9413	5 x 8 mm	10 bar (145 PSI)
				19 958 9417	6.5 x 10 mm	10 bar (145 PSI)
				19 958 9421	8 x 12 mm	10 bar (145 PSI)
			15 m	19 958 9425	11 x 16 mm	10 bar (145 PSI)
				19 958 9560	8 x 12 mm	16 bar (232 PSI)
				19 958 9301	9.5 x 13.5 mm	16 bar (232 PSI)
SERIES 315 ESAFE	Spiral	2.0 m	19 958 9563	11 x 16 mm	12 bar (174 PSI)	
			19 958 9561	8 x 12 mm	16 bar (232 PSI)	
			19 958 9564	11 x 16 mm	12 bar (174 PSI)	
		4.0 m	19 958 9370	6.5 x 10 mm	10 bar (145 PSI)	
			19 958 9374	8 x 12 mm	10 bar (145 PSI)	
			19 958 9378	11 x 16 mm	10 bar (145 PSI)	
		6.0 m	19 958 9371	6.5 x 10 mm	10 bar (145 PSI)	
			19 958 9375	8 x 12 mm	10 bar (145 PSI)	
			19 958 9379	11 x 16 mm	10 bar (145 PSI)	
		8.0 m	19 958 9372	6.5 x 10 mm	10 bar (145 PSI)	
			19 958 9376	8 x 12 mm	10 bar (145 PSI)	
			19 958 9380	11 x 16 mm	10 bar (145 PSI)	
Straight Braided	10 m	19 958 9373	6.5 x 10 mm	10 bar (145 PSI)		
		19 958 9377	8 x 12 mm	10 bar (145 PSI)		
		19 958 9381	11 x 16 mm	10 bar (145 PSI)		
15 m	19 958 9203	11 x 16 mm	12 bar (174 PSI)			
	19 958 9201	9.5 x 13.5 mm	16 bar (232 PSI)			
15 m	19 958 9202	9.5 x 13.5 mm	16 bar (232 PSI)			



CEJN Safety

CEJN reserves the right to make changes without further notification. Thread connections are listed according to ISO Standards. Other connections and sealing material on request. Check with an authorized CEJN distributor for availability and prices. Some part numbers may be subject to minimum order quantities. Please visit our website, www.cejn.com, for general maintenance tips.

AIR FLOW

- HOSE 5X8 MM
- HOSE 6.5X10 MM
- HOSE 8X12 MM
- HOSE 9.5X13.5 MM
- HOSE 11X16 MM

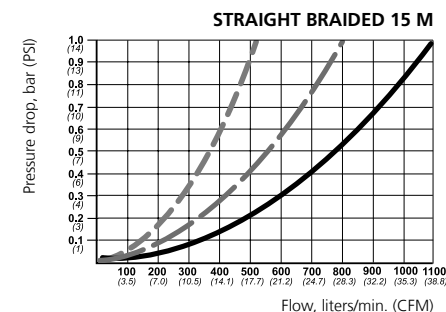
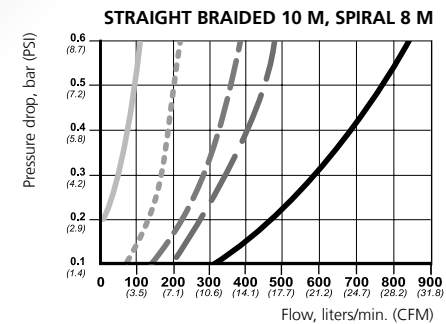
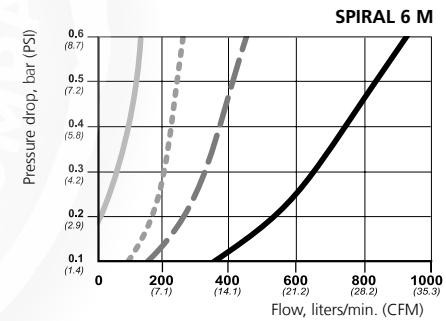
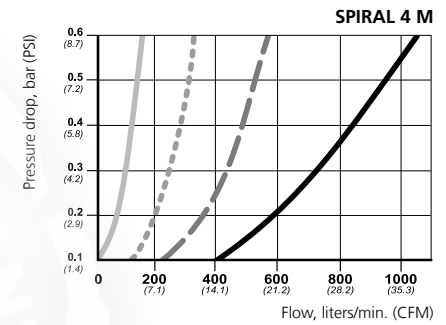
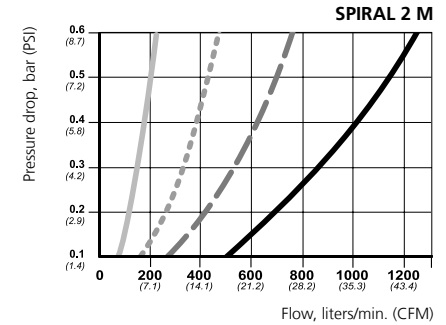

1:1

PUR Hose Kits – with Series 320

CEJN Original, Eurostandard 7.4 mm

- Series 320 couplings and nipples
- Flexible PUR hose with long service life
- Pre-assembled and ready to use

CEJN Hose Kits come pre-assembled and ready for immediate use. They consist of an extremely flexible, straight braided or spiral polyurethane (PUR) hose combined with Series 320 Standard or eSafe couplings and nipples with reusable Stream-Line connections.

PUR Hose Kits are also available with Series 300, 310 and 410 Standard or Vented Safety couplings and nipples.



Flow capacity is measured at 6 bar (87 PSI) inlet pressure, and pressure drop at 0.5 bar (7 PSI).

		Service length	Part No.	ID x OD	Max working pressure	
SERIES 320	Spiral	2.0 m	19 958 9907	5 x 8 mm	10 bar (145 PSI)	
			19 958 9910	6.5 x 10 mm	10 bar (145 PSI)	
			19 958 9914	8 x 12 mm	10 bar (145 PSI)	
		19 958 9917	11 x 16 mm	10 bar (145 PSI)		
		4.0 m	19 958 9903	5 x 8 mm	10 bar (145 PSI)	
			19 958 9904	6.5 x 10 mm	10 bar (145 PSI)	
			19 958 9905	8 x 12 mm	10 bar (145 PSI)	
		6.0 m	19 958 9906	11 x 16 mm	10 bar (145 PSI)	
			19 958 9908	5 x 8 mm	10 bar (145 PSI)	
			19 958 9912	6.5 x 10 mm	10 bar (145 PSI)	
	8.0 m	19 958 9915	8 x 12 mm	10 bar (145 PSI)		
		19 958 9918	11 x 16 mm	10 bar (145 PSI)		
		19 958 9909	5 x 8 mm	10 bar (145 PSI)		
	Straight Braided	10.0 m	19 958 9913	6.5 x 10 mm	10 bar (145 PSI)	
			19 958 9916	8 x 12 mm	10 bar (145 PSI)	
			19 958 9919	11 x 16 mm	10 bar (145 PSI)	
		15.0 m	19 958 9829	8 x 12 mm	16 bar (232 PSI)	
			19 958 9339	9.5 x 13.5 mm	16 bar (232 PSI)	
			19 958 9737	11 x 16 mm	12 bar (174 PSI)	
		SERIES 320, ESAFE	Spiral	2.0 m	19 958 9830	8 x 12 mm
19 958 9340					9.5 x 13.5 mm	16 bar (232 PSI)
4.0 m				19 958 9748	11 x 16 mm	12 bar (174 PSI)
				19 958 9763	6.5 x 10 mm	10 bar (145 PSI)
Straight Braided	10.0 m	19 958 9762	8 x 12 mm	10 bar (145 PSI)		
		19 958 9767	11 x 16 mm	10 bar (145 PSI)		
		19 958 9764	6.5 x 10 mm	10 bar (145 PSI)		
	15.0 m	19 958 9706	8 x 12 mm	10 bar (145 PSI)		
		19 958 9768	11 x 16 mm	10 bar (145 PSI)		
		19 958 9765	6.5 x 10 mm	10 bar (145 PSI)		
	SERIES 320, ESAFE	Straight Braided	10.0 m	19 958 9707	8 x 12 mm	10 bar (145 PSI)
				19 958 9769	11 x 16 mm	10 bar (145 PSI)
			15.0 m	19 958 9708	8 x 12 mm	10 bar (145 PSI)
				19 958 9770	11 x 16 mm	10 bar (145 PSI)
15.0 m	19 958 9738	11 x 16 mm	12 bar (174 PSI)			
	19 958 9341	9.5 x 13.5 mm	16 bar (232 PSI)			
19 958 9342	9.5 x 13.5 mm	16 bar (232 PSI)				



CEJN Safety

CEJN reserves the right to make changes without further notification. Thread connections are listed according to ISO Standards. Other connections and sealing material on request. Check with an authorized CEJN distributor for availability and prices. Some part numbers may be subject to minimum order quantities. Please visit our website, www.cejn.com, for general maintenance tips.

AIR FLOW

- HOSE 5X8 MM
- HOSE 6.5X10 MM
- HOSE 8X12 MM
- HOSE 9.5X13.5 MM
- HOSE 11X16 MM

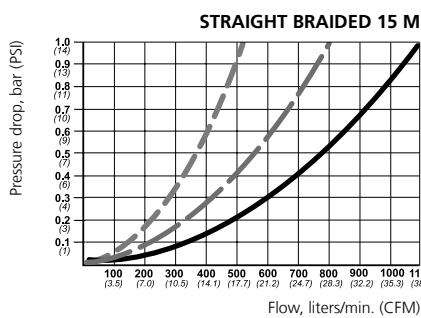
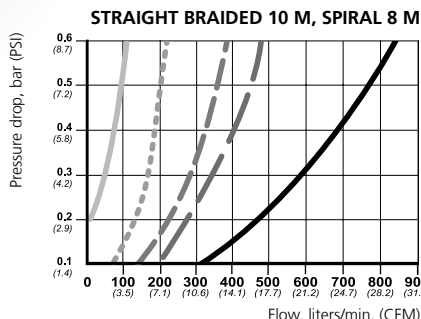
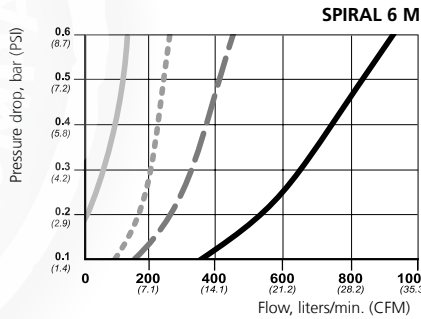
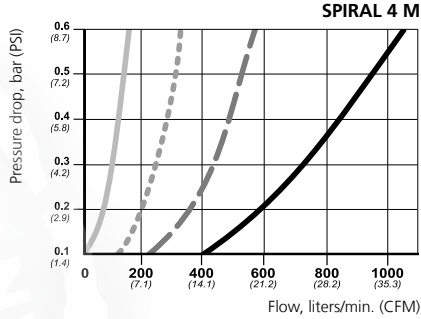
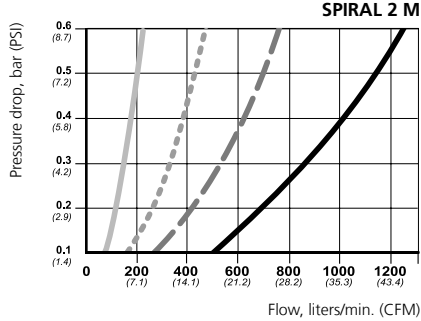

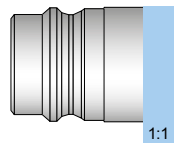

PUR Hose Kits – with Series 410

CEJN, Eurostandard 10.4

- **Series 410 couplings and nipples**
- **Flexible PUR hose with long service life**
- **Pre-assembled and ready to use**

CEJN Hose Kits come pre-assembled and ready for immediate use. They consist of an extremely flexible, straight braided or spiral polyurethane (PUR) hose combined with Series 410 Vented Safety couplings and nipples with reusable Stream-Line connections.

PUR Hose Kits are also available with Series 300, 310 and 320 Standard or Vented Safety couplings and nipples.



- HOSE 2 M 11X16 MM
- HOSE 4 M 11X16 MM
- HOSE 6 M 11X16 MM
- HOSE 8 M 11X16 MM
- HOSE 10 M 13X18 MM
- HOSE 15 M 13X18 MM

AIR FLOW

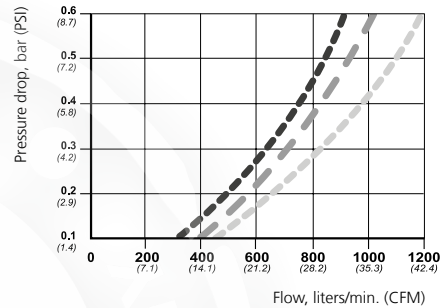
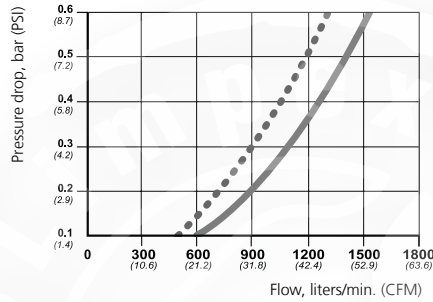

Flow capacity is measured at 6 bar (87 PSI) inlet pressure, and pressure drop at 0.5 bar (7 PSI).

		Service length	Part No.	ID x OD	Max working pressure
SERIES 410, ESAFE	Spiral	2.0 m	19 958 9485	11 x 16 mm	10 bar (145 PSI)
		4.0 m	19 958 9486	11 x 16 mm	10 bar (145 PSI)
		6.0 m	19 958 9487	11 x 16 mm	10 bar (145 PSI)
		8.0 m	19 958 9488	11 x 16 mm	10 bar (145 PSI)
	Straight Braided	10.0 m	19 958 9347	13 x 18 mm	10 bar (145 PSI)
		15.0 m	19 958 9348	13 x 18 mm	10 bar (145 PSI)

Antistatic Hose Kits

- **Combined with couplings and nipples**
- **Flexible EPDM rubber hose that dissipates electro-static discharge**
- **Pre-assembled and ready to use**

CEJN Antistatic Hose Kits come pre-assembled and ready for immediate use. They consist of an extremely flexible, straight-braided EPDM rubber hose combined with couplings and nipples. The kits are designed for applications in which media causes excessive static charge or where a static discharge has the potential to cause explosion or damage.



AIR FLOW

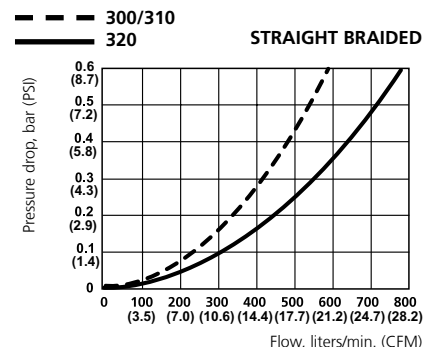

		Service length	Part No.	ID x OD	Max working pressure
SERIES	Series 310	10 m	19 900 9931	10 x 17,5	12 bar (174 PSI)
	Series 320	10 m	19 900 9923	10 x 17,5	12 bar (174 PSI)
	Series 300	10 m	19 900 9804	10 x 17,5	12 bar (174 PSI)

CEJN reserves the right to make changes without further notification. Thread connections are listed according to ISO Standards. Other connections and sealing material on request. Check with an authorized CEJN distributor for availability and prices. Some part numbers may be subject to minimum order quantities. Please visit our website, www.cejn.com, for general maintenance tips.

PUR Hose Kits – with Adapters and Accessories

- **Hose kits in different configurations**
- **Light and flexible hose**
- **Pre-assembled and ready to use**

CEJN Hose Kits are available as spiral hose pre-assembled with: swivel adapters, fixed adapters or different types of blowguns. Each kit is ready for immediate use without the need for tools. The content of the kits are reusable, airtight and will not need follow-up tightening.

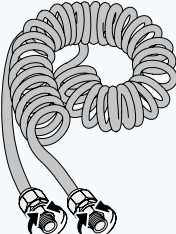
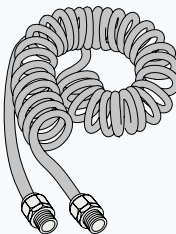
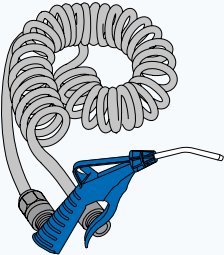

	Service length	Part No.	ID x OD	Connection 1	Connection 2	Description	
SWIVEL & THREADED 	2 m	19 958 9978	5 x 8 mm	R 1/4" swiveling	R 1/4" swiveling	-	
		19 958 9947	6.5 x 10 mm	R 1/4" swiveling	R 1/4" swiveling	-	
		19 958 9997	8 x 12 mm	R 3/8" swiveling	R 3/8" swiveling	-	
	4 m	19 958 9965	5 x 8 mm	R 1/4" swiveling	R 1/4" swiveling	-	
		19 958 9949	6.5 x 10 mm	R 1/4" swiveling	R 1/4" swiveling	-	
		19 958 9967	8 x 12 mm	R 3/8" swiveling	R 3/8" swiveling	-	
	6 m	19 958 9810	11 x 16 mm	R 1/2" swiveling	R 1/2" swiveling	-	
		19 958 9954	6.5 x 10 mm	R 1/4" swiveling	R 1/4" swiveling	-	
	8 m	19 958 9998	8 x 12 mm	R 3/8" swiveling	R 3/8" swiveling	-	
		19 958 9957	6.5 x 10 mm	R 1/4" swiveling	R 1/4" swiveling	-	
		19 958 9809	8 x 12 mm	R 3/8" swiveling	R 3/8" swiveling	-	
		19 958 9346	11 x 16 mm	R 1/2" swiveling	R 1/2" swiveling	-	
FIXED & THREADED 	2 m	19 958 9987	6.5 x 10 mm	R 1/4"	R 1/4"	-	
		19 958 9325	5 x 8 mm	R 1/4"	R 1/4"	-	
	4 m	19 958 9988	6.5 x 10 mm	R 1/4"	R 1/4"	-	
		19 958 9805	8 x 12 mm	R 3/8"	R 3/8"	-	
		19 958 9885	11 x 16 mm	R 1/2"	R 1/2"	-	
	6 m	19 958 9955	6.5 x 10 mm	R 1/4"	R 1/4"	-	
		19 958 9804	8 x 12 mm	R 3/8"	R 3/8"	-	
	8 m	19 958 9801	8 x 12 mm	R 3/8"	R 3/8"	-	
		19 958 9862	11 x 16 mm	R 1/2"	R 1/2"	-	
	HOSE KITS WITH BLOWGUN 	2 m	19 958 9326	5 x 8 mm	320 nipple	320 coupling	208 Star-Tip. Removable tube + Assembled nipple
			19 958 9327	6,5 x 10 mm	320 nipple	320 coupling	208 Std. Fixed tube + Assembled nipple
		4 m	19 958 9328	6,5 x 10 mm	320 nipple	320 coupling	208 Star-Tip. Removable tube + Assembled nipple
19 958 9746			6,5 x 10 mm	320 nipple	320 coupling	208 Star-Tip. 10 320 1152 + Nipple assembled on blowgun.	
19 958 9360			6.5 x 10 mm	320 nipple	320 coupling	210 MultiFLOW adjustable nozzle+ assembled nipple	
19 958 9332			8 x 12 mm	320 nipple	320 coupling	208 Std. Fixed tube + Assembled nipple	
19 958 9333			8 x 12 mm	310 nipple	310 coupling	208 Std. Fixed tube + Assembled nipple	
19 958 9361			8 x 12 mm	320 nipple	320 coupling	210 MultiFLOW adjustable nozzle+ assembled nipple	
6 m		19 958 9329	6,5 x 10 mm	300 nipple	300 coupling	208 Star-Tip. Removable tube + Assembled nipple	
		19 958 9334	8 x 12 mm	320 nipple	320 coupling	208 Std. Fixed tube + Assembled nipple	

CEJN reserves the right to make changes without further notification. Thread connections are listed according to ISO Standards. Other connections and sealing material on request. Check with an authorized CEJN distributor for availability and prices. Some part numbers may be subject to minimum order quantities. Please visit our website, www.cejn.com, for general maintenance tips.



Air & Fluid Guns

– Depend on CEJN's high quality tools for premium performance

CEJN Series 208 blowguns are designed to be lightweight, comfortable to handle and suitable for both left and right-handed users. The handle is pleasant to grip and shields against cold air flow. CEJN Series 208 blowguns are offered in standard full-flow, noise-reducing Star-Tip and pressure-regulated safety versions.

By transforming customer needs into design features – a CEJN trademark – CEJN developed the MultiFLOW 210 Air & Fluid Gun. Its powerful force and exceptional flow control make the job a whole lot easier whether the job calls for cleaning with air or with water, drying or cooling.

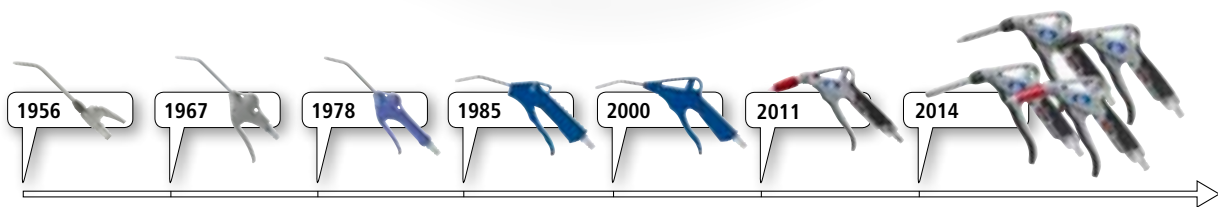

OK

All products marked with the "OK" symbol are compliant with OSHA instruction STD 1-13.1: "...when dead-ending occurs, static pressure at the main orifice shall not exceed 2 bar (30 PSI). All products marked with the "ear" symbol have a sound level below 85 dB(A) and meet the EU Machine Directive §1.5.8 concerning noise reduction demands. Compliance with above listed directives is measured at 6 bar (87 PSI) inlet pressure.

OK

Star-Tip - Incorporates six separate outlets, which result in a silencing effect, as well as meet OSHA safety standards.

Air & Fluid Guns – Series 208

- **High blowing force**
- **Easily regulated infinite flow**
- **Ergonomic, comfortable controls**

The CEJN Series 208 blowgun has a valve package that enables it to handle both air as well as non-explosive fluids. The Seires is offered in several styles, including standard full-flow, noise-reducing Star-Tip, and a pressure-regulated safety version. Various tubes and tips are available to meet specific application requirements.







TECHNICAL DATA

Material blowgun..... POM (body), brass (valve, tube)
Media..... Air and non-explosive water based liquids
Material seal..... NBR (Nitrile)
Min. burst pressure..... 64 bar (928 PSI)
Temperature range..... -20°C – +60°C (-4°F – +140°F)

Flow capacity is measured at 6 bar (87 PSI) inlet pressure, and pressure drop at 0.5 bar (7 PSI).

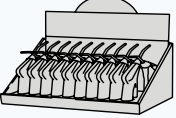
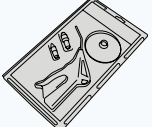

	Part No.	Tube	Connection	Weight	Sound level	Flow capacity	Max working pressure
BASIC BLOWGUN BODY 	11 208 0000	R 1/4" thread	R 1/4"	76 g (2.7 oz)	- dB	- l/min (- CFM)	16 bar (232 PSI)
	11 208 0050	1/4" NPT thread	NPT 1/4"	76 g (2.7 oz)	- dB	- l/min (- CFM)	16 bar (232 PSI)
90 MM TUBE 	11 208 0100	Fixed tube	R 1/4"	96 g (3.4 oz)	96 dB	500 l/min (17.7 CFM)	16 bar (232 PSI)
	11 208 0150	Fixed tube	NPT 1/4"	96 g (3.4 oz)	96 dB	500 l/min (17.7 CFM)	16 bar (232 PSI)
	11 208 0200	Removable tube	R 1/4"	96 g (3.4 oz)	94 dB	500 l/min (17.7 CFM)	16 bar (232 PSI)
	11 208 0250	Removable tube	NPT 1/4"	96 g (3.4 oz)	94 dB	500 l/min (17.7 CFM)	16 bar (232 PSI)
REGULATOR 	11 208 0300	Removable tube	R 1/4"	110 g (3.9 oz)	93 dB	250 l/min (8.8 CFM)	8 bar (116 PSI)
	11 208 0350	Removable tube	NPT 1/4"	110 g (3.9 oz)	93 dB	250 l/min (8.8 CFM)	8 bar (116 PSI)
90 MM TUBE WITH STAR-TIP 	11 208 3100	Fixed tube	R 1/4"	96 g (3.4 oz)	79 dB	190 l/min (6.7 CFM)	16 bar (232 PSI)
	11 208 3150	Fixed tube	NPT 1/4"	96 g (3.4 oz)	79 dB	190 l/min (6.7 CFM)	16 bar (232 PSI)
	11 208 3200	Removable tube	R 1/4"	96 g (3.4 oz)	79 dB	190 l/min (6.7 CFM)	16 bar (232 PSI)
	11 208 3250	Removable tube	NPT 1/4"	96 g (3.4 oz)	79 dB	190 l/min (6.7 CFM)	16 bar (232 PSI)
20-PIECE DISPLAY PACK (11 208 0100) 	11 208 9984	Fixed tube	R 1/4"	2746 g (96.7 oz)	96 dB	500 l/min (17.7 CFM)	16 bar (232 PSI)
BLISTER KIT (11 208 0100 + 11 208 9955 + 11 208 9962 + 11 208 9956) 	71 208 1911	Fixed tube	R 1/4"	g (oz)	96 dB	500 l/min (17.7 CFM)	16 bar (232 PSI)

CEJN reserves the right to make changes without further notification. Thread connections are listed according to ISO Standards. Other connections and sealing material on request. Check with an authorized CEJN distributor for availability and prices. Some part numbers may be subject to minimum order quantities. Please visit our website, www.cejn.com, for general maintenance tips.

MultiFLOW Air & Fluid Gun – Series 210

- **Unmatched blowing force**
- **Adjustable flow control**
- **Ergonomical, non-slip grip**

CEJN's MultiFLOW blowgun effectively cleans surfaces with air or water with unparalleled blowing force. Precise flow is achieved by adjustable flow settings. Nozzle adjusts from narrow jet to wide beam. The MultiFLOW meets and exceeds OSHA safety standards when dead-ended.







CEJN Safety

TECHNICAL DATA

Material blowgun	POM, TPE, Aluminum
Media	Air and non-explosive water based liquids
Material seal.....	NBR (Nitrile)
Max. working pressure.....	16 bar (232 PSI)
Min. burst pressure.....	64 bar (928 PSI)
Temperature range	+60°C – +80°C (140°F – +176°F) @ 10 bar (145 PSI) Working pressure
Temperature range	-20°C – +60°C (-4°F – +140°F) @ 16 bar (232 PSI) Working pressure
Sound level.....	79 dB - 103 dB

Flow capacity is measured at 6 bar (87 PSI) inlet pressure.

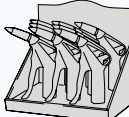
	Part No.	Connection	Air flow min-max	Fluid flow min-max
	11 210 0400	320 nipple	200 - 1200 l/min (7.1 – 42.4 CFM)	5 - 25 l/min (1.3 – 6.6GPM)
	11 210 0430	Fluid nipple	200 - 1200 l/min (7.1 – 42.4 CFM)	5 - 25 l/min (1.3 – 6.6GPM)
	11 210 0450	Adapter 1/4"	200 - 1200 l/min (7.1 – 42.4 CFM)	5 - 25 l/min (1.3 – 6.6GPM)
	11 210 0455	G 1/2" Brass	200 - 1200 l/min (7.1 – 42.4 CFM)	5 - 25 l/min (1.3 – 6.6GPM)
	11 210 0100	320 nipple	150 - 1100 l/min (5.3 – 38.8 CFM)	
	11 210 0150	NPT 1/4"	150 - 1100 l/min (5.3 – 38.8 CFM)	
	11 210 0152	G 1/4" Brass	150 - 1100 l/min (5.3 – 38.8 CFM)	
	11 210 3100	320 nipple	100 - 700 l/min (3.5 – 24.7 CFM)	
	11 210 3150	NPT 1/4"	100 - 1100 l/min (3.5 – 38.8 CFM)	
	11 210 3152	G 1/4" Brass	100 - 1100 l/min (3.5 – 38.8 CFM)	
	11 210 0340	417 nipple Brass		3.5 - 15 l/min (0.9 – 4.0GPM)
	11 210 0352	G 1/4" Brass		3.5 - 15 l/min (0.9 – 4.0GPM)
	11 210 0355	G 1/2" Brass		3.5 - 15 l/min (0.9 – 4.0GPM)
	11 210 9980	320 nipple	200 - 1200 l/min (7.1 – 42.4 CFM)	5 - 25 l/min (1.3 – 6.6GPM)
	11 210 9981	Adapter 1/4"	200 - 1200 l/min (7.1 – 42.4 CFM)	5 - 25 l/min (1.3 – 6.6GPM)











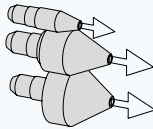
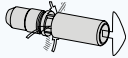

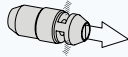

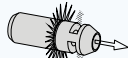

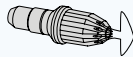
CEJN reserves the right to make changes without further notification. Thread connections are listed according to ISO Standards. Other connections and sealing material on request. Check with an authorized CEJN distributor for availability and prices. Some part numbers may be subject to minimum order quantities. Please visit our website, www.cejn.com, for general maintenance tips.



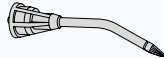

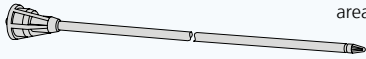
Air & Fluid Guns Accessories – Removable

- Removable nozzles
- Extension tubes in various lengths
- Safety versions diverts the air when dead-ended
- Noise reducing versions

Removable accessories for Series 208 and 210 blowguns. Various tubes and tips are available to meet specific application requirements.

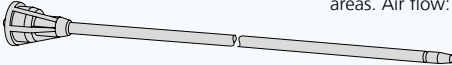

	Description	Connection 1	Part No.
RUBBER-TIP NOZZLE 	Fits directly onto the tube. For use against sensitive surfaces. Suitable for pressurizing, such as in leakage or cylinder testing. Nozzle available in three sizes, individually and as a set.	Ø 14 mm (1/2")	11 208 9956
		Ø 25 mm (1")	11 208 9957
		Ø 35 mm (1 1/3")	11 208 9958
		3-piece set (Ø 14, 25 and 35)	11 208 9960
VENTURI NOZZLE  	Fits directly onto the tube. Draws in ambient air for extra-high flow. Increases air flow by 100%. Suitable for deflecting lightweight wood chips and diverts air when dead-ended, reducing the outlet pressure to less than 2 bar (29 PSI).	-	11 208 9963
BYPASS NOZZLE  	Fits directly onto the tube. When dead-ended, pressure is released (or diverted) through the side outlets, reducing the maximum outlet pressure to less than 2 bar (29 PSI).	-	11 208 9961
AIR CURTAIN NOZZLE  	Fits directly onto the tube. Creates a protective air curtain that is suitable for deflecting lightweight chips or fluids and diverts air when dead-ended, reducing the outlet pressure to less than 29 PSI (2 bar).	-	11 208 9954
CHIP SHIELD 	Fits directly onto the tube. Protects operators from flyaway chip debris. For placement anywhere on the tube. Nitrile bushing for easy mounting. Translucent shield diameter: 100 mm (4")	-	11 208 9955
SILENCER  	Fits directly onto the tube. Reduces noise effectively when low noise is a requirement. Sound level: 82 dB(A).	-	11 208 9962
SILENCER NOZZLE  	Fits directly onto the threads of blowgun body. For use when space is limited.	-	11 208 9965
STAR-TIP TUBE  	Fits directly onto the threads of blowgun body. Air flow: 190 l/min (7 CFM).	90 mm (4")	11 208 3215
EXTENSION TUBE  	Fits directly onto the threads of blowgun body. Offers increased access in hard-to-reach areas, along with silencing and OSHA-compliant features. Air flow: 180 l/min (6 CFM)	300 mm (12")	11 208 3219
		500 mm (20")	11 208 3220
TUBE REGULATOR  	Fits directly onto the threads of blowgun body. Reduces the outlet pressure to a safe level in the event of blockage in the tube or when dead-ended.	90 mm (4")	11 208 0216

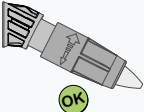
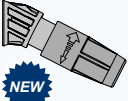
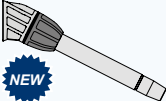
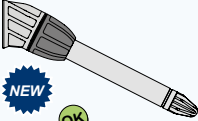
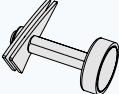
	Description	Connection 1	Part No.
TUBE 	Fits directly onto the threads of blowgun body. Air flow: 500 l/min (18 CFM).	90 mm (4")	11 208 0215
EXTENSION TUBE 	Fits directly onto the threads of blowgun body. Offers increased access in hard-to-reach areas. Air flow: 380 l/min (13 CFM)	300 mm (12") 500 mm (20")	11 208 0219 11 208 0220
BENDABLE EXTENSION TUBE 	Fits directly onto the threads of blowgun body. Can be bent and adjusted for specific tasks in hard-to-reach areas. Bendable 6-mm (1/4") coated copper tube. Air flow: 120 l/min (4 CFM)	400 mm (16")	11 208 0222
SPRAYER KIT 	The CEJN Sprayer Kit includes a 208 blowgun that can be detached and used separately. The nozzle is designed to spray a full, dense mist for optimum cleaning. Fluid flow and fluid/air mixture can be easily adjusted. The OSHA-compliant spray nozzle bowl makes the product safe to use. Max working pressure 16 bar (230 PSI). Canister capacity 1.2 l (0,26 gl UK).	Rc 1/4" air connection	11 208 3180
SPRAYER ATTACHMENT 	Turns the blowgun into a sprayer for cleaning liquid and other chemicals (not to be used with detachable tubes). Requires the 208 90-mm (4") standard outlet tube. Meets OSHA requirements. Max working pressure 16 bar (230 PSI). Canister capacity 1.2 l (0,26 gl UK)	Blowgun 208	12 010 3137
ADJUSTABLE JET NOZZLE 	Fits directly onto the threads of blowgun 210 body. Nozzle adjusts flow from a narrow jet for reaching hard to-to-remove debris to a wide beam for cleaning wide-open surface.	Blowgun 210	11 210 0200
ADJUSTABLE FLUID NOZZLE 	Fits directly onto the threads of blowgun 210 body. Nozzle adjusts flow from a narrow jet for reaching hard to-to-remove debris to a wide beam for cleaning wide-open surface with liquid media.	Blowgun 210	11 210 0210
STRAIGHT TUBE 	Fits directly onto the threads of blowgun 210 body. The 90 mm (4") tube is straight for optimal handling ergonomics.	Blowgun 210	11 210 0220
STAR-TIP TUBE 	Fits directly onto the threads of blowgun 210 body. The 90 mm (4") tube is straight for optimal handling ergonomics. The Star-tip feature diverts the air when dead-ended making it OSHA-compliant.	Blowgun 210	11 210 0230
MAGNET HOLDER 	By complementing the blow gun Series 208 and 210 with a magnet holder, customers facilitate the daily work and increase the flexibility of the suspension. The holder is easily assembled on either the right or left hand side of the gun.	Blowgun 210	11 210 9000

CEJN reserves the right to make changes without further notification. Thread connections are listed according to ISO Standards. Other connections and sealing material on request. Check with an authorized CEJN distributor for availability and prices. Some part numbers may be subject to minimum order quantities. Please visit our website, www.cejn.com, for general maintenance tips.



Hose & Cable Reels

– Hose & Cable Reels for safe, efficient workplaces

CEJN Hose and Cable Reels are the high-quality choice for industries and workshops that want the best professional option on the market with its high flow rate, low pressure drop and sturdy exterior. The lightweight design of polyurethane hose makes CEJN hose reels easy to manoeuvre. The smooth outer layer of the hose ensures flawless feeding action without tangles.

Among special features of CEJN reels is a stop function that can be disengaged, allowing continuous feeding action. The spring force can be adjusted for operator comfort and to compensate for different weight and balance requirements. The reels can be ceiling or wall-mounted with no adjustment required and offer full, 300-degree movement.

All hose reels are CE marked.

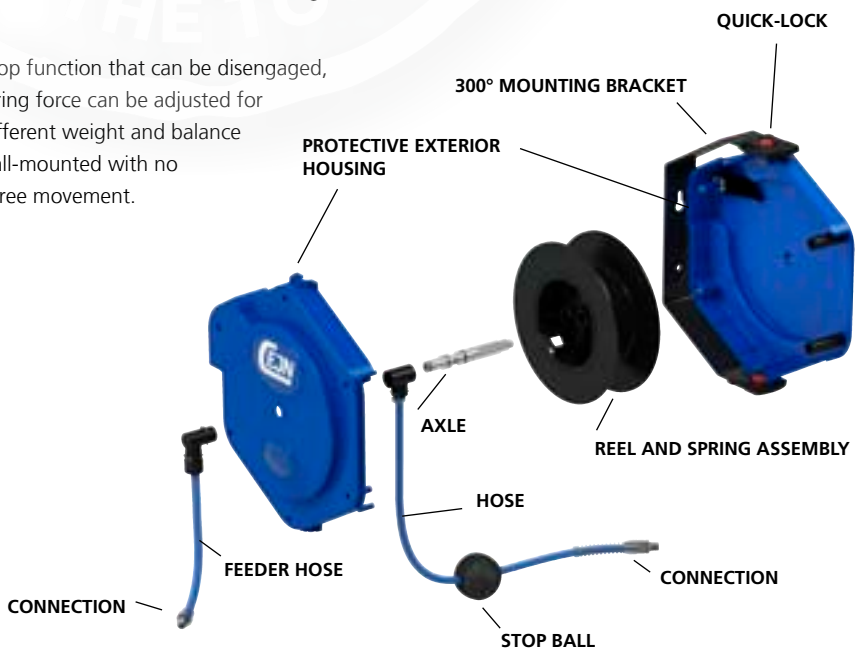

Compressed Air Hose Reels

- High flow capacity
- Low pressure drop
- Strong and durable



CEJN Hose Reels for compressed air feature high-quality, oil-resistant polyurethane hose. The feeder hose connection, axle and swivel design ensures a high flow rate and low pressure drop, securing top performance. The reel and spring assembly is tested to endure hours of hard use. The reels can swivel 300° making it possible for the operator to move around freely and the low pulling force makes it easy for anyone to handle. The impact resistant casing protects the hose and reel mechanism from dirt and debris. The Quick-Locks on the mounting bracket makes installation and service quick and easy. The Hose Reels are available in several casing sizes and hose dimensions, as well as with CEJN braided anti-spark hose. All hose reels are supplied with a feeder hose.

Hose reels for water applications and cable reels for electrical applications are also available.

TECHNICAL DATA

Feeder hose length 2 m (6.6 ft)
 Hose material Braided PUR
 Connections Male thread
 Temperature range -20°C – +60°C (-4°F – +140°F)

- 19 911 501X
- 19 911 510X
- 19 911 10X0
- 19 911 512X
- 19 911 502X
- 19 911 513X

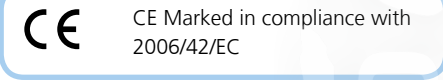

AIR FLOW

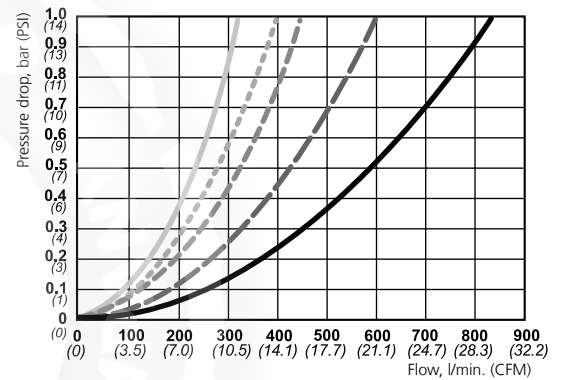

		Part No.	ID x OD	Connection	Reel diameter	Weight	Max. working pressure (20°C, 68°F)
SMALL REEL	7 meters	19 911 5020	8 x 12	R 1/4"	330 mm	3.9 kg	16 bar (232 PSI)
		19 911 5021	8 x 12	NPT 1/4"	330 mm	3.9 kg	16 bar (232 PSI)
	9 meters	19 911 5010	6.5 x 10	R 1/4"	330 mm	3.9 kg	16 bar (232 PSI)
		19 911 5011	6.5 x 10	NPT 1/4"	330 mm	3.9 kg	16 bar (232 PSI)
MEDIUM REEL	10 meters	19 911 1000	8 x 12	R 1/4"	390 mm	5.5 kg	16 bar (232 PSI)
		19 911 1050	8 x 12	NPT 1/4"	390 mm	5.5 kg	16 bar (232 PSI)
LARGE REEL	10 meter	19 911 5130	11 x 16	R 1/2"	430 mm	6.6 kg	12 bar (174 PSI)
		19 911 5131	11 x 16	NPT 1/2"	430 mm	6.6 kg	12 bar (174 PSI)
	14 meters	19 911 5120	9.5 x 13.5	R 1/4"	430 mm	6.3 kg	12 bar (174 PSI)
		19 911 5121	9.5 x 13.5	NPT 1/4"	430 mm	6.3 kg	12 bar (174 PSI)
	16 meters	19 911 5100	8 x 12	R 1/4"	430 mm	6.3 kg	12 bar (174 PSI)
		19 911 5101	8 x 12	NPT 1/4"	430 mm	6.3 kg	12 bar (174 PSI)
LARGE REEL WITH ANTI-SPARK HOSE	14 meters	19 911 5125	9.5 x 13.5	R 1/4"	430 mm	6.3 kg	12 bar (174 PSI)
		19 911 5126	9.5 x 13.5	NPT 1/4"	430 mm	6.3 kg	12 bar (174 PSI)

CEJN reserves the right to make changes without further notification. Thread connections are listed according to ISO Standards. Other connections and sealing material on request. Check with an authorized CEJN distributor for availability and prices. Some part numbers may be subject to minimum order quantities. Please visit our website, www.cejn.com, for general maintenance tips.

Water Hose Reels

- Suitable for damp or wet environments
- Compatible with water-based fluids, such as acetylene glycol
- Strong and durable

CEJN water hose reels are ideal for wash-down applications, fluid-filling stations, and personnel rinse areas. They are also an excellent choice for compressed air in damp and wet environments. When used exclusively for water, the green color of the hose makes it distinguishable from CEJN compressed air hose reels. A feeder hose is included.

Hose reels for compressed air applications and cable reels for electrical applications are also available.



TECHNICAL DATA **WATER FLOW**

Feeder hose length 2 m (6.6 ft)
Hose material Braided PUR
Connections Male thread
Temperature range 5°C – +60°C (41°F – +140°F)

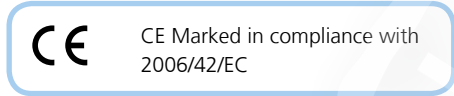
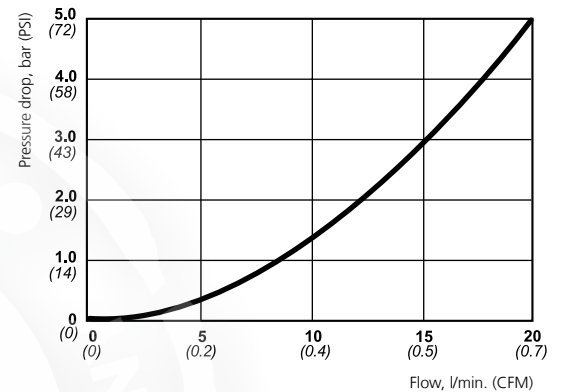

		Part No.	ID x OD	Connection	Reel diameter	Weight	Max working pressure (20°C, 68°F)
WATER	14 meter	19 911 5140	9.5 x 13.5	R 1/4"	430 mm	6.3 kg	9 bar (130 PSI)
		19 911 5141	9.5 x 13.5	NPT 1/4"	430 mm	6.3 kg	9 bar (130 PSI)

Electrical – Cable Reels

- Sturdy housing protects enclosed cable and reel mechanism
- Strong and durable
- Flexible high quality rubber cable

CEJN electrical cable reels feature a high quality rubber cable and are supplied with a thermal overload protection circuit, which cuts off the electrical supply in the event of a power surge. The Quick-Lock feature on the mounting bracket makes installation and service quick and easy. The reels can be ceiling- or wall-mounted and swivel 300°.

Hose reels for compressed air and water applications are also available.



TECHNICAL DATA

Material cable Rubber H07RN-F
Cable dimension 3 x 1.5 mm
Voltage 230 V
Protection class IP 23
Temperature range 5°C – +60°C (41°F – +140°F)

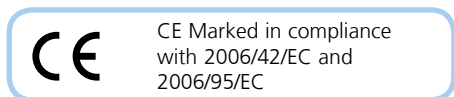

		Part No.	Connection	Reel diameter	Weight	Power output fully unwound	Power output fully wound	Current
SMALL REEL	10 meter	19 911 5050	Schuko plug	330 mm	4.6 kg	3500 W	1500 W	16 A
		19 911 5052	CH plug	330 mm	4.6 kg	2300 W	1500 W	10 A
LARGE REEL	17 meter	19 911 5150	Schuko plug	430 mm	6.7 kg	3500 W	1000 W	16 A
		19 911 5152	CH plug	430 mm	6.7 kg	2300 W	1000 W	10 A

CEJN reserves the right to make changes without further notification. Thread connections are listed according to ISO Standards. Other connections and sealing material on request. Check with an authorized CEJN distributor for availability and prices. Some part numbers may be subject to minimum order quantities. Please visit our website, www.cejn.com, for general maintenance tips.

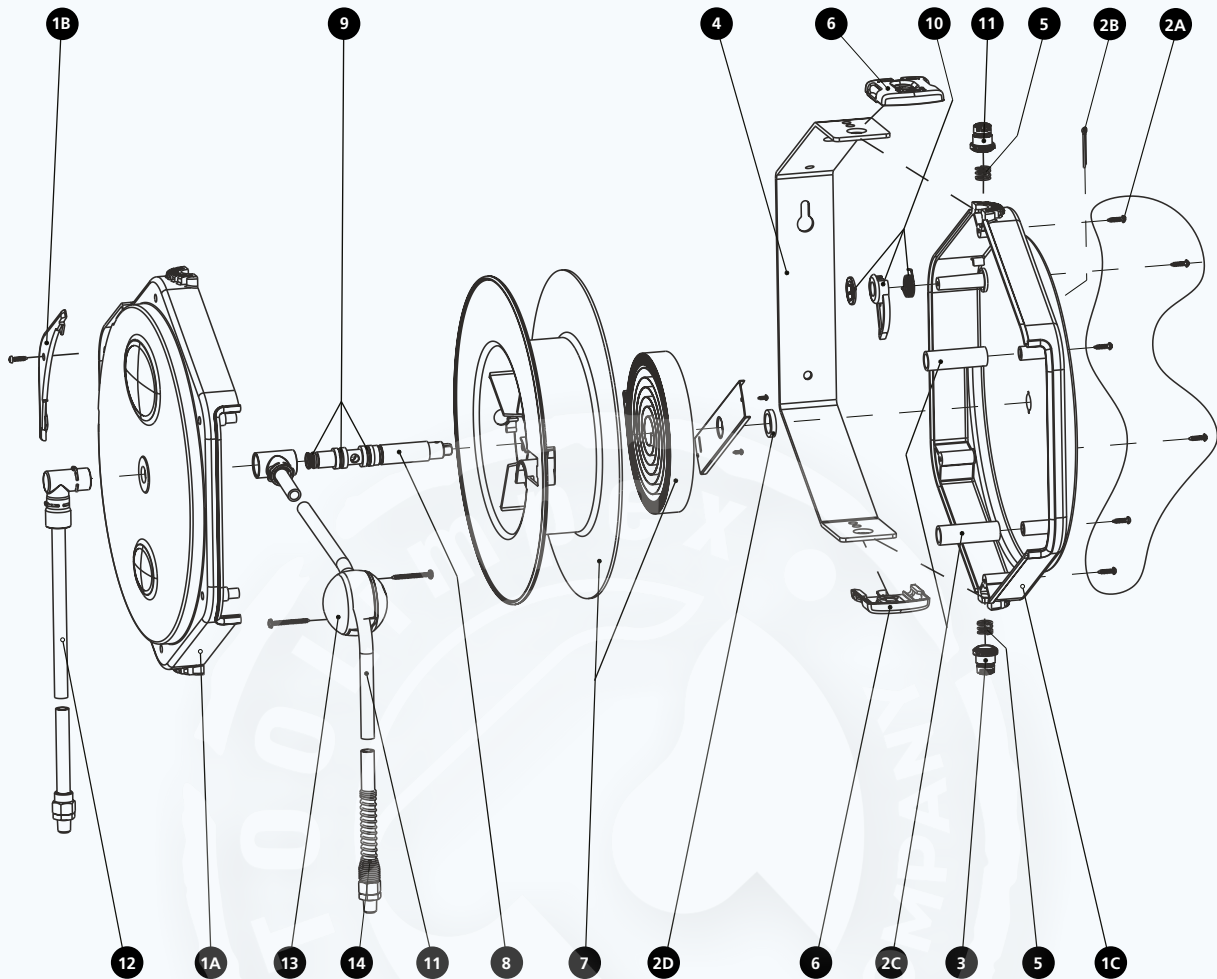

Hose Reels Spare Parts

Real Connection:	6.5 x 10, 9 m	8 x 12, 7m	8 x 12, 10 m	8 x 12, 16m	9.5 x 13.5, 14 m	9.5 x 13.5, 14 m	9.5 x 13.5, 14 m	11 x 16, 10 m
R thread	19 911 5010	19 911 5020	19 911 1000	19 911 5100	19 911 5120	19 911 5125	19 911 5140	19 911 5130
NPT thread	19 911 5011	19 911 5021	19 911 1050	19 911 5101	19 911 5121	19 911 5126	19 911 5141	19 911 5131
1 (1A, 1B, 1C, 2B)	19 911 5075	19 911 5075	19 911 5209	19 911 5208	19 911 5208	19 911 5208	19 911 5208	19 911 5208
2 (2A, 2B, 2C, 2D)	19 911 5175	19 911 5175	19 911 5175	19 911 5175	19 911 5175	19 911 5175	19 911 5175	19 911 5175
3	09 249 5025	09 249 5025	09 249 5025	09 249 5025	09 249 5025	09 249 5025	09 249 5025	09 249 5025
4	09 249 5131	09 249 5131	09 249 5132	09 249 5130	09 249 5130	09 249 5130	09 249 5130	09 249 5130
5	09 410 3200	09 410 3200	09 410 3200	09 410 3200	09 410 3200	09 410 3200	09 410 3200	09 410 3200
6	09 249 5056	09 249 5056	09 249 5056	09 249 5056	09 249 5056	09 249 5056	09 249 5056	09 249 5056
7	19 911 5076	19 911 5076	19 911 5076	19 911 5172	19 911 5172	19 911 5172	19 911 5172	19 911 5172
8	09 245 5127	09 245 5127	09 245 5127	09 245 5127	09 245 5127	09 245 5127	09 245 5127	09 245 5127
9	19 911 5235	19 911 5235	19 911 5235	19 911 5235	19 911 5235	19 911 5235	19 911 5235	19 911 5235
10	19 911 5234	19 911 5234	19 911 5233	19 911 5234	19 911 5234	19 911 5234	19 911 5234	19 911 5234
11 R thread	19 911 5220	19 911 5219	19 911 5225	19 911 5218	19 911 5216	19 911 5223	19 911 5232	19 911 5221
11 NPT thread		19 911 5228	19 911 5226	19 911 5184				
12	19 911 5217	19 911 5217	19 911 5217	19 911 5217	19 911 5215	19 911 5224	19 911 5231	19 911 5222
13	19 911 5170	19 911 5170	19 911 5170	19 911 5170	19 911 5170	19 911 5170	19 911 5170	19 911 5207
14 R	19 958 1013	19 958 1213	19 958 1213	19 958 1213	19 958 1313	19 958 1313	19 958 1313	19 958 1616
14 NPTReal	19 958 1043	19 958 1243	19 958 1243	19 958 1243	19 958 1343	19 958 1343	19 958 1343	19 958 1646

* When ordering Housing pos 1, a safety pin pos 2B is included. Our recommendation is to order a Screw kit pos 2 also together with the Housing.



FRL Products

– Advanced FRL Range offers numerous connection sizes

The CEJN Filtration, Regulation, and Lubrication (FRL) range offers quality products for ensuring reliable, compressed air performance. CEJN FRL products are offered in 1/8 inch to 1 inch thread connection sizes. They are easy to assemble and maintain and can be top or side-mounted.

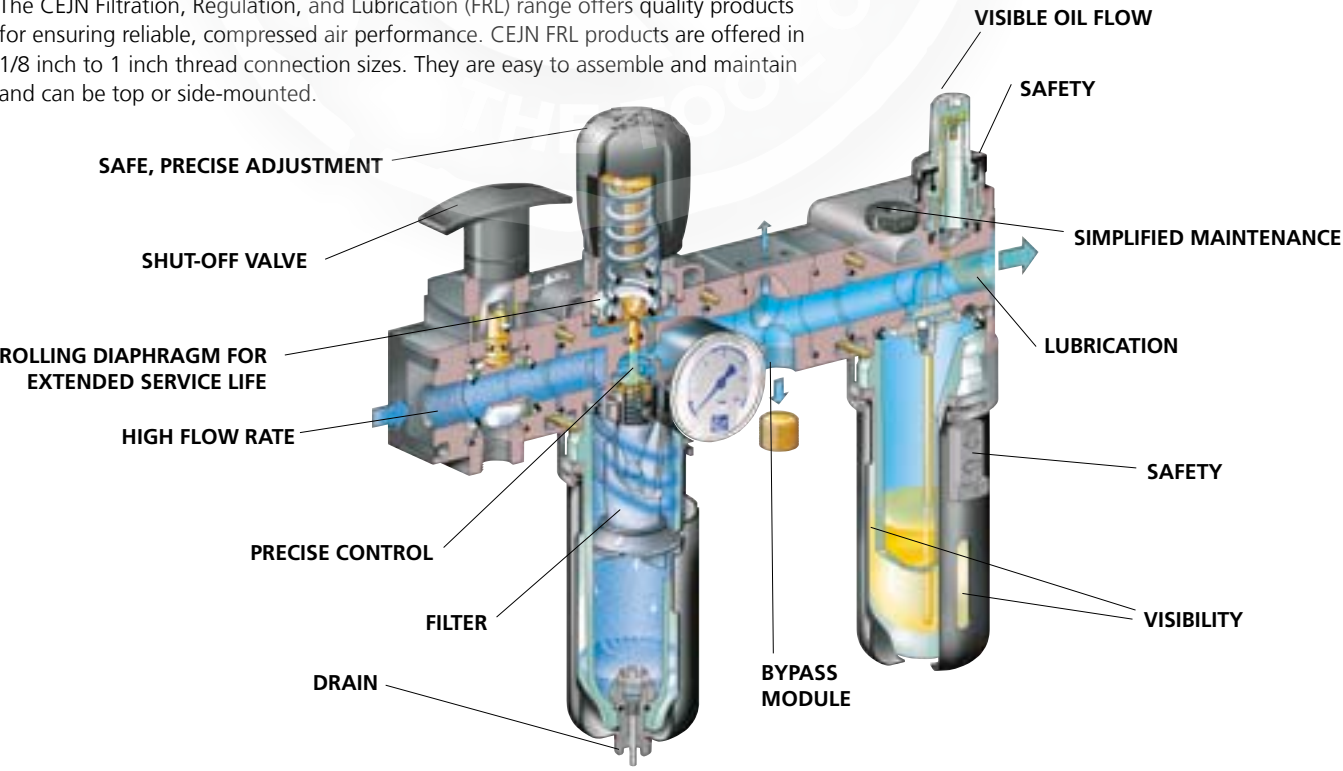

FRL Systems

- Complete, pre-assembled sets
- Compact design
- Gauge included

CEJN FRL systems are designed to take the burden off of customers in selecting individual air-treatment products. They combine a filter, regulator, and lubricator in a ready-to-use set. The system concept also simplifies ordering procedures, since only one part number is required to order multiple products. For details on system components, refer to the following pages.



TECHNICAL DATA	Model 107	Model 112	Model 160
Media	Compressed air, neutral gas	Compressed air, neutral gas	Compressed air, neutral gas
Max. working pressure @ 23°C	16 bar (232 PSI)	16 bar (232 PSI)	17.5 bar (253 PSI)
Max. working pressure @ 50°C	10 bar (145 PSI)	10 bar (145 PSI)	12 bar (174 PSI)
Temperature range	0°C – +50°C (32°F – +122°F)	0°C – +50°C (32°F – +122°F)	0°C – +50°C (32°F – +122°F)
Filtering element	Polyethylene (PE)	Polyethylene (PE)	Sintered bronze
Material body	Polymer	Painted zamak	Painted aluminium
Material bowl	Polycarbonate (PC) resistant to UV	Polycarbonate (PC) resistant to UV, with protector	Metal with level window in polypropylene
Material bowl protector	With safety locking and condensate level view	With safety locking and condensate level view	With safety locking and condensate level view
Condensate drain	Semi-automatic	Semi-automatic	Pipeable semi-automatic
Controlled pressure	0.5 - 10 bar (7 - 145 PSI)	0.5 - 10 bar (7 - 145 PSI)	0.5 - 12 bar (7 - 145 PSI)
Hysteresis	0.3 bar (4 PSI)	0.3 bar (4 PSI)	0.5 bar (7 PSI)
Regulating device	Rolling diaphragm	Rolling diaphragm (very low hysteresis)	Rolling diaphragm (very low hysteresis)
Material seal	Nitrile	Nitrile	Nitrile
Lubrication	Selective oil fog	Selective oil fog	Selective oil fog
Lubrication oil	Non-detergent without aggressive additives	Non-detergent without aggressive additives	Non-detergent without aggressive additives
Oil refilling	Unpressurized	Pressurized	Pressurized

Flow capacity is measured at 8 bar (116 PSI) inlet pressure, with a set point at 6.3 bar (91.4 PSI) and pressure drop at 1 bar (14.5 PSI).

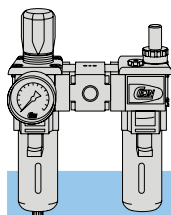

	Model	Part No.	Connection	Bowl capacity (cl)	Max oil capacity (cl)	Gauge diameter (mm)	Filtration (µm)	Min flow		Max flow	
								(l/min)	(CFM)	(l/min)	(CFM)
Filter/Regulator & Lubricator	107	19 903 1602	G 1/4"	7	4	40	25	20	0.7	1300	45.9
	112	19 903 5604	G 3/8"	12	7	50	25	20	0.7	3000	105.9
		19 903 5605	G 1/2"	12	7	50	25	20	0.7	3000	105.9
	160	19 903 2607	G 3/4"	50	36	50	30	20	0.7	3000	105.9
		19 903 2609	G 1"	50	36	50	30	90	3.2	13500	476.6

CEJN reserves the right to make changes without further notification. Thread connections are listed according to ISO Standards. Other connections and sealing material on request. Check with an authorized CEJN distributor for availability and prices. Some part numbers may be subject to minimum order quantities. Please visit our website, www.cejn.com, for general maintenance tips.

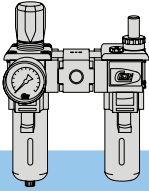

Note: 107 and 112: 25 µm filtration, 160: 30 µm filtration

	Model	Part No.	Connection	Bowl capacity (cl)	Max oil capacity (cl)	Gauge diameter (mm)	Filtration	Min flow		Max flow	
							(µm)	(l/min)	(CFM)	(l/min)	(CFM)
Filter/Regulator, Porting Block & Lubricator	107	19 903 1612	G 1/4"	7	4	40	25	20	0.7	1300	45.9
	112	19 903 5614	G 3/8"	12	7	50	25	20	0.7	3000	105.9
		19 903 5615	G 1/2"	12	7	50	25	20	0.7	3000	105.9
	160	19 903 2617	G 3/4"	50	36	50	30	90	3.2	11000	388.3
		19 903 2619	G 1"	50	36	50	30	90	3.2	13500	476.6

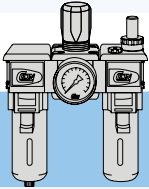

	Model	Part No.	Connection	Bowl capacity (cl)	Max oil capacity (cl)	Gauge diameter (mm)	Filtration	Min flow		Max flow	
							(µm)	(l/min)	(CFM)	(l/min)	(CFM)
Filter, Regulator & Lubricator	107	19 903 1622	G 1/4"	7	4	40	25	20	0.7	1300	45.9
	112	19 903 5624	G 3/8"	12	7	50	25	20	0.7	3000	105.9
		19 903 5625	G 1/2"	12	7	50	25	20	0.7	3000	105.9
	160	19 903 2627	G 3/4"	50	36	50	30	90	3.2	11000	388.3
		19 903 2629	G 1"	50	36	50	30	90	3.2	13500	476.6

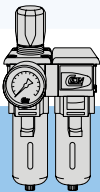

	Model	Part No.	Connection	Bowl capacity (cl)	Max oil capacity (cl)	Gauge diameter (mm)	Filtration	Min flow		Max flow	
							(µm)	(l/min)	(CFM)	(l/min)	(CFM)
Filter/Regulator 5 µm & Filter 0.01 µm	112	19 903 5634	G 3/8"	12	-	50	0.01	20	0.7	1050	37.1
		19 903 5635	G 1/2"	12	-	50	0.01	20	0.7	1050	37.1

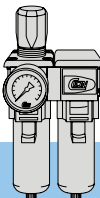

	Model	Part No.	Connection	Bowl capacity (cl)	Max oil capacity (cl)	Gauge diameter (mm)	Filtration	Min flow		Max flow	
							(µm)	(l/min)	(CFM)	(l/min)	(CFM)
Filter/Regulator 5 µm & Filter 0.01 µm with metal bowl	112	19 903 5654	G 3/8"	12	-	50	0.01	20	0.7	1050	37.1
		19 903 5655	G 1/2"	12	-	50	0.01	20	0.7	1050	37.1

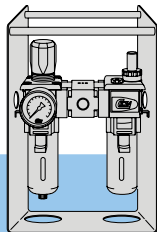

Note: 25 µm filtration

	Model	Part No.	Connection	Bowl capacity (cl)	Max oil capacity (cl)	Gauge diameter (mm)	Filtration	Min flow		Max flow	
							(µm)	(l/min)	(CFM)	(l/min)	(CFM)
Portable System - Filter, Regulator & Lubricator	112	19 903 5645	G 1/2"	12	7	50	25	20	0.7	3000	105.9

ACCESSORIES & SPARE PARTS

	Model 107	Model 112	Model 160
Side-mounting brackets	19 903 1510	19 903 5510	19 903 2510

CEJN reserves the right to make changes without further notification. Thread connections are listed according to ISO Standards. Other connections and sealing material on request. Check with an authorized CEJN distributor for availability and prices. Some part numbers may be subject to minimum order quantities. Please visit our website, www.cejn.com, for general maintenance tips.

Filters

- **Excellent filtration of water and dirt**
- **Quick and easy removal and replacement of filter element**
- **Semi-automatic drain as standard**

CEJN filters offer high flow capacity and withstand up to 17.5 bar (253.8 PSI) inlet pressure. Features include a metal bowl protector, easily visible level indicators, and a compact modular construction. Filtration up to 99.9% can be achieved with a 0.01 µm filter.



TECHNICAL DATA	Model 107	Model 112	Model 160
Media	Compressed air, neutral gas	Compressed air, neutral gas	Compressed air, neutral gas
Max. working pressure @ 23°C	16 bar (232 PSI)	16 bar (232 PSI)	17.5 bar (253 PSI)
Max. working pressure @ 50°C	10 bar (145 PSI)	10 bar (145 PSI)	12 bar (174 PSI)
Temperature range	0°C – +50°C (32°F – +122°F)	0°C – +50°C (32°F – +122°F)	0°C – +50°C (32°F – +122°F)
Filtering element	Polyethylene (PE)	Polyethylene (PE)	Sintered bronze
Material body	Painted zamak	Painted zamak	Painted aluminium
Material bowl	Polycarbonate (PC) resistant to UV, with protector	Polycarbonate (PC) resistant to UV, with protector	Metal with level window in polypropylene
Material bowl protector	With safety locking and condensate level view	With safety locking and condensate level view	-
Condensate drain	Semi-automatic	Semi-automatic	Pipeable semi-automatic

Flow capacity is measured at 6.3 bar (91.4 PSI) inlet pressure, and pressure drop at 1 bar (14.5 PSI).

Filters	Model	Part No.	Connection	Bowl capacity (cl)	Filtration (µm)	Max flow		
						(l/min)	(CFM)	
	107	19 903 1102	G 1/4"	7	25	1450	51.2	
		19 903 1112		7	5	1230	43.4	
		19 903 1122		7	0.01	700	24.7	
	112	19 903 5104	G 3/8"	12	25	2400	84.7	
		19 903 5114		12	5	2040	72.0	
		19 903 5105	G 1/2"	12	25	2400	84.7	
		19 903 5115		12	5	2040	72.0	
	160	19 903 5125	G 3/4"	12	0.01	1050	37.1	
		19 903 2107		50	30	9000	317.7	
		19 903 2109		50	30	9800	345.9	
					50	30	9800	345.9

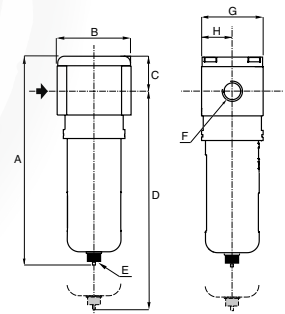

Note: In front of a 0.01 µm filter, the installation of a 5 µm filter is recommended using the special two-part kit below.

Model	A	B	C	D	E	F	G	H
107	159.5	42	25.5	190	G 1/8"	G 1/4"	42	40
112	191	66	30.5	221.5	G 1/8"	G 3/8"	55	46
160	245	90	30	325	6 mm	G 3/4"	94	47

ACCESSORIES & SPARE PARTS

	Model 107	Model 112	Model 160
Two-part Assembly kit	19 903 1500	19 903 5500	19 903 2500
Two-part Assembly kit special for 0.01µm filter	19 903 1505	19 903 5505	-
Side-mounting brackets	19 903 1510	19 903 5510	19 903 2510
Automatic drain	19 903 1560	19 903 5560	19 903 2560

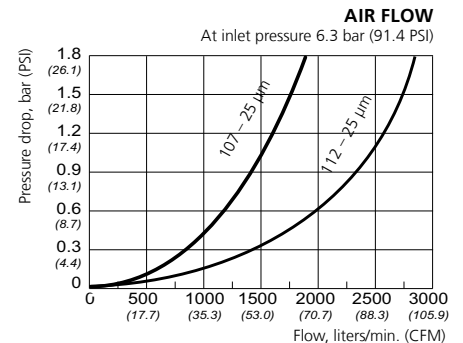

CEJN reserves the right to make changes without further notification. Thread connections are listed according to ISO Standards. Other connections and sealing material on request. Check with an authorized CEJN distributor for availability and prices. Some part numbers may be subject to minimum order quantities. Please visit our website, www.cejn.com, for general maintenance tips.

Regulators

- High flow capacity
- Effortless, precise regulation
- Excellent hysteresis

CEJN regulators feature a locking device, a flexible rolling diaphragm, and a gauge. A mini-version with thread connections down to 1/8-inch is available for use when space is limited.



TECHNICAL DATA	Model Mini	Model 107	Model 112	Model 160
Media	Compressed air, neutral gas	Compressed air, neutral gas	Compressed air, neutral gas	Compressed air, neutral gas
Max. working pressure	12 bar (170 PSI)	16 bar (230 PSI)	16 bar (230 PSI)	17.5 bar (250 PSI)
Temperature range	0°C – +50°C (32°F – +122°F)	10°C – +60°C (50°F – +140°F)	10°C – +60°C (50°F – +140°F)	10°C – +60°C (50°F – +140°F)
Material body	Polymer	Painted zamak	Painted zamak	Painted aluminium
Controlled pressure	0.5 - 10 bar (10- 150 PSI)	0.5 - 10 bar (10- 150 PSI)	0.5 - 10 bar (10- 150 PSI)	0.5 - 12 bar (10- 170 PSI)
Hysteresis	0.35 bar (5.1 PSI)	0.3 bar (4.4 PSI)	0.2 bar (2.9 PSI)	0.4 bar (5.8 PSI)
Regulating device	Rolling diaphragm (very low hysteresis)	Rolling diaphragm (very low hysteresis)	Rolling diaphragm (very low hysteresis)	Diaphragm
Material seal	Nitrile	Nitrile	Nitrile	Nitrile

Flow capacity is measured at 8 bar (116 PSI) inlet pressure, with a set point at 6.3 bar (91.4 PSI) and pressure drop at 1 bar (14.5 PSI).

Regulators	Model	Part No.	Connection	Max inlet pressure		Controlled pressure		Max flow	
				(bar)	(PSI)	(bar)	(PSI)	(l/min)	(CFM)
	Mini	19 903 8201	G 1/8"	12	174	10	145	500	17.7
		19 903 8202	G 1/4"	12	174	10	145	650	22.9
	107	19 903 1202		16	232	10	145	1300	45.9
	112	19 903 5204	G 3/8"	16	232	10	145	3000	105.9
		19 903 5205	G 1/2"	16	232	10	145	3000	105.9
	160	19 903 2207	G 3/4"	17.5	253	12	174	12000	423.6
		19 903 2209	G 1"	17.5	253	12	174	16500	582.5

Model	A	B	C	D	F	G	H	I	J	L
Mini	74	45	G 1/8"	G 1/8"	20	40	40	71	39	3
107	104	42	G 1/8"	G 1/4"	21	42	42	76	51	2
112	125	66	G 1/8"	G 3/8"	27.5	55	55	87	61	2
160	182	90	G 1/8"	G 3/4"	47	94	94	126	85	5

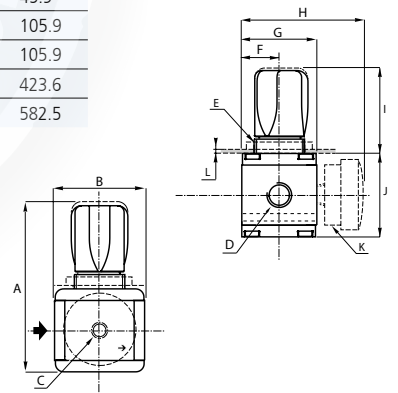

ACCESSORIES & SPARE PARTS

	Model MINI	Model 107	Model 112	Model 160
Two-part Assembly kit	-	-	19 903 1500	19 903 2500
Top-mounting ring bracket	19 903 8511*	19 903 8511	19 903 1511	-
Side-mounting brackets	-	-	19 903 1510	19 903 2510
Gauges	19 903 1525	19 903 1525	19 903 1525	19 903 1525
	19 903 1520	19 903 1520	19 903 1520	19 903 1520
Plug 1/8"	19 903 1550	19 903 1550	19 903 1550	-

* Mounting ring is included with regulator.

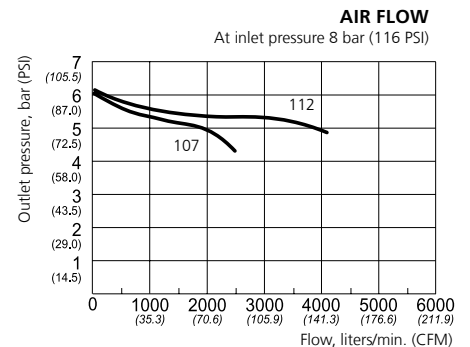

CEJN reserves the right to make changes without further notification. Thread connections are listed according to ISO Standards. Other connections and sealing material on request. Check with an authorized CEJN distributor for availability and prices. Some part numbers may be subject to minimum order quantities. Please visit our website, www.cejn.com, for general maintenance tips.

Filter/Regulators

- **Excellent filtration of water and dirt**
- **High flow capacity**
- **Excellent hysteresis**

CEJN filter/regulator units combine a filter, regulator, and gauge in one economical unit. The combination units withstand up to 17.5 bar (253.8 PSI) inlet pressure. Features include a metal bowl protector, easily visible level indicators, compact modular construction, flexible rolling diaphragm, and locking device.



TECHNICAL DATA	Model 107	Model 112	Model 160
Media	Compressed air, neutral gas	Compressed air, neutral gas	Compressed air, neutral gas
Max. working pressure @ 23°C	16 bar (230 PSI)	16 bar (230 PSI)	17.5 bar (250 PSI)
Max. working pressure @ 50°C	10 bar (150 PSI)	10 bar (150 PSI)	12 bar (170 PSI)
Temperature range	0°C – +50°C (32°F – +122°F)	0°C – +50°C (32°F – +122°F)	0°C – +50°C (32°F – +122°F)
Filtering element	Polyethylene (PE)	Polyethylene (PE)	Sintered bronze
Material body	Painted zamak	Painted zamak	Painted aluminium
Material bowl	Polycarbonate (PC) resistant to UV	Polycarbonate (PC) resistant to UV	Metal with level window in polypropylene
Material bowl protector	With safety locking and condensate level view	With safety locking and condensate level view	-
Condensate drain	Semi-automatic	Semi-automatic	Pipeable semi-automatic
Controlled pressure	0.5 - 10 bar (7 - 145 PSI)	0.5 - 10 bar (7 - 145 PSI)	0.5 - 12 bar (7 - 174 PSI)
Hysteresis	0.3 bar (4.9 PSI)	0.2 bar (2.9 PSI)	0.4 bar (5.8 PSI)
Regulating device	Rolling diaphragm	Rolling diaphragm (very low hysteresis)	Rolling diaphragm (very low hysteresis)
Material seal	Nitrile	Nitrile	Nitrile

Flow capacity is measured at 8 bar (116 PSI) inlet pressure, with a set point at 6.3 bar (91.4 PSI) and pressure drop at 1 bar (14.5 PSI).

	Model	Part No.	Connection	Bowl capacity (cl)	Filtration (µm)	Max flow		Controlled pressure	
						(l/min)	(CFM)	(bar)	(PSI)
	107	19 903 1402	G 1/4"	7	25	1300	45.9	0.5-10	7-145
		19 903 1412	G 1/4"	7	5	1100	38.8	0.5-10	7-145
	112	19 903 5404	G 3/8"	12	25	3000	105.9	0.5-10	7-145
		19 903 5414	G 3/8"	12	5	2500	88.3	0.5-10	7-145
		19 903 5405	G 1/2"	12	25	3000	105.9	0.5-10	7-145
	160	19 903 5415	G 1/2"	12	5	2500	88.3	0.5-10	7-145
		19 903 2407	G 3/4"	50	30	11000	388.3	0.5-12	7-174
		19 903 2409	G 1"	50	30	15700	554.2	0.5-12	7-174

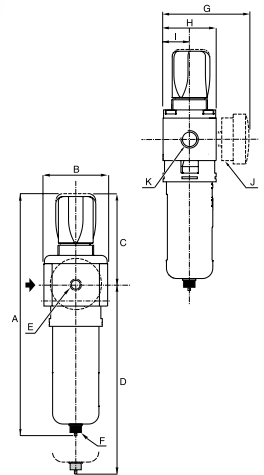

Model	A	B	C	D	E	F	G	H	I	K
107	213	42	79	190	G 1/8"	G 1/8"	95	42	21	G 1/4"
112	251	66	94.5	221.5	G 1/8"	G 1/8"	105	55	27.5	G 3/8"
160	345	90	133	292	G 1/8"	6 mm	126	94	47	G 3/4"

ACCESSORIES & SPARE PARTS

	Model 107	Model 112	Model 160
Two-part Assembly kit	19 903 1500	19 903 5500	19 903 2500
Top-mounting ring bracket	19 903 1511	19 903 5511	-
Side-mounting brackets	19 903 1510	19 903 1510	19 903 2510
Automatic drain	19 903 1560	19 903 5560	19 903 2560
Gauges	19 903 1525	19 903 1525	19 903 1525
	19 903 1520	19 903 1520	19 903 1520
Plug 1/8"	19 903 1550	19 903 1550	-

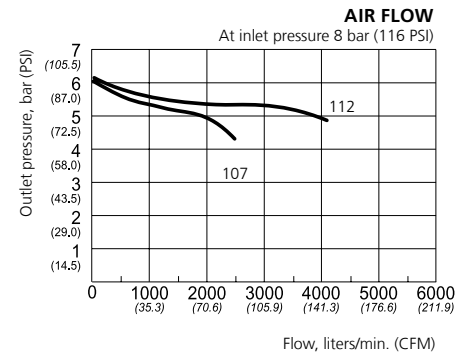

CEJN reserves the right to make changes without further notification. Thread connections are listed according to ISO Standards. Other connections and sealing material on request. Check with an authorized CEJN distributor for availability and prices. Some part numbers may be subject to minimum order quantities. Please visit our website, www.cejn.com, for general maintenance tips.

Lubricators

- **Lubrication corresponds accurately to variations or changes in air flow**
- **Refillable under pressure**
- **Easy adjustment**

CEJN lubricators can be adjusted easily without tools. Features include a lockable oil setting knob and a transparent sight glass offering visible oil flow from all directions. Models 112 and 160 are refillable under pressure.



TECHNICAL DATA	Model 107	Model 112	Model 160
Media	Compressed air, neutral gas	Compressed air, neutral gas	Compressed air, neutral gas
Max. working pressure @ 23°C	12 bar (170 PSI)	12 bar (170 PSI)	17.5 bar (250 PSI)
Max. working pressure @ 50°C	10 bar (150 PSI)	10 bar (150 PSI)	12 bar (170 PSI)
Temperature range	0°C – +50°C (32°F – +122°F)	0°C – +50°C (32°F – +122°F)	0°C – +50°C (32°F – +122°F)
Material body	Painted zamak	Painted zamak	Painted aluminium
Material bowl	Polycarbonate (PC) resistant to UV	Polycarbonate (PC) resistant to UV	Metal with level window in polypropylene
Material bowl protector	With safety locking and condensate level view	With safety locking and condensate level view	-
Lubrication	Selective oil fog	Selective oil fog	Selective oil fog
Lubrication oil	Non-detergent without aggressive additives	Non-detergent without aggressive additives	Non-detergent without aggressive additives
Oil refilling	Unpressurized	Pressurized	Pressurized

Flow capacity is measured at 6.3 bar (91.4 PSI) inlet pressure, and pressure drop at 1 bar (14.5 PSI).

Lubricators	Model	Part No.	Connection	Bowl capacity (cl)	Max oil capacity (cl)	Min flow*		Max flow	
						(l/min)	(CFM)	(l/min)	(CFM)
	107	19 903 1302	G 1/4"	7	4	20	0.7	3500	123.6
	112	19 903 5304	G 3/8"	12	7	20	0.7	550	19.4
		19 903 5305	G 1/2"	12	7	20	0.7	550	19.4
	160	19 903 2307	G 3/4"	50	36	90	3.2	16000	564.8
		19 903 2309	G 1"	50	36	90	3.2	17700	624.8

* Minimum for lubricator startup

Model	A	B	C	D	E	F
107	42	187	215	42	21	G 1/4"
112	66	215	243	55	27.5	G 3/8", G 1/2"
160	90	247	240	94	47	G 3/4"

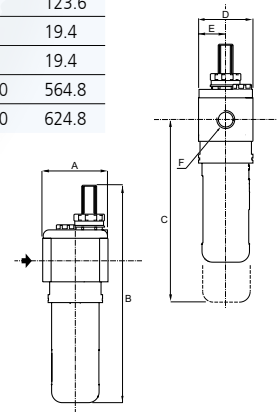

ACCESSORIES & SPARE PARTS

	Model 107	Model 112	Model 160
Two-part Assembly kit	19 903 1500	19 903 5500	19 903 2500
Side-mounting brackets	19 903 1510	19 903 1510	19 903 2510

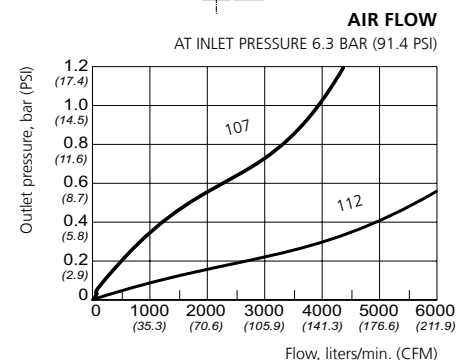



CEJN reserves the right to make changes without further notification. Thread connections are listed according to ISO Standards. Other connections and sealing material on request. Check with an authorized CEJN distributor for availability and prices. Some part numbers may be subject to minimum order quantities. Please visit our website, www.cejn.com, for general maintenance tips.

FRL Products – Accessories & Spare Parts

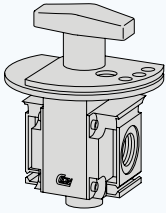
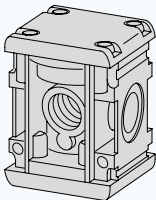
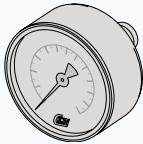

- **Mounting and assembly kits**
- **Service accessories**
- **Blocks and gauges**

CEJN offers a large range of accessories and spare parts for the FRL product line such as ball valves, gauges and bowls for both filters and lubricators. Also available are porting blocks, assembly kits and brackets to create a FRL-system that meet specific application requirements.

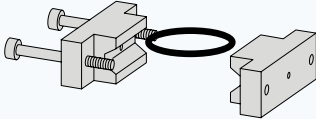

	Category description		Description	Part No.
BALL VALVES 	Shut off and vent the secondary side (G 1/4" exhaust port) during service and maintenance procedures. Max. working pressure 17.5 bar (253.8 PSI)	107	Shut-off valve, G 1/4" (padlockable)	19 903 1532
	Shut off and vent the secondary side (G 1/4" exhaust port) during service and maintenance procedures. Max. working pressure 17.5 bar (253.8 PSI)	112	Shut-off valve, G 3/8"	19 903 5534
			Shut-off valve, G 3/8" (padlockable)	19 903 5554
			Shut-off valve, G 1/2"	19 903 5535
			Shut-off valve, G 1/2" (padlockable)	19 903 5555
PORTING BLOCKS 	Designed with one, two, or three outlet ports, in addition to the main body. Max. working pressure 16 bar (232 PSI).	107	Porting block G 1/4" with two G 1/8" bypass ports	19 903 1952
		112	Porting block G 3/8" with three G 3/8" bypass ports	19 903 5954
			Porting block G 1/2" with three G 3/8" bypass ports	19 903 5955
GAUGES 	Pressure meter for porting blocks and FRL units. G 1/8" male connection	Mini / 107	Ø 40 mm pressure gauge 0-12 bar / 0-174 PSI	19 903 1525
			Ø 40 mm pressure gauge 0-4 bar / 0-58 PSI	19 903 1526
		112 / 160	Ø 50 mm pressure gauge 0-12 bar / 0-174 PSI	19 903 1520
			Ø 50 mm pressure gauge 0-16 bar / 0-232 PSI	19 903 1521
PLUG 1/8" 	Plug for gauge port 1/8"	Mini / 107 / 112	Plug for gauge port 1/8"	19 903 1550
TWO-PART ASSEMBLY KIT 	Used to assemble FRL products to one unit	107	Two-part Assembly kit special for 0.01µm filter	19 903 1505
		112	Two-part Assembly kit special for 0.01µm filter	19 903 5505
		107	Two-part Assembly kit	19 903 1500
	Used to assemble FRL products to one unit	112	Two-part Assembly kit	19 903 5500
	Used to assemble FRL products to one unit.	160	Two-part Assembly kit	19 903 2500

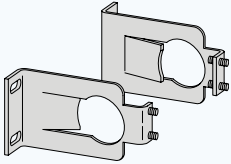
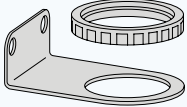
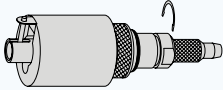
CEJN reserves the right to make changes without further notification. Thread connections are listed according to ISO Standards. Other connections and sealing material on request. Check with an authorized CEJN distributor for availability and prices. Some part numbers may be subject to minimum order quantities. Please visit our website, www.cejn.com, for general maintenance tips.

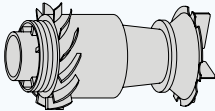
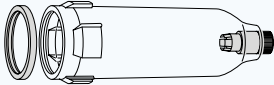
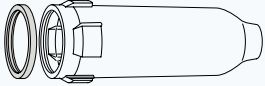
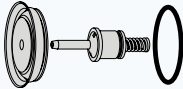
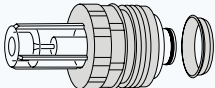
	Category description		Description	Part No.
	Used to mount units on a wall, etc.	107	Side-mounting brackets	19 903 1510
		112	Side-mounting brackets	19 903 5510
		160	Side-mounting brackets	19 903 2510
	Used along with brackets to mount regulators and filter/regulators on a wall	Mini	Top-mounting bracket (ring included in regulator)	19 903 8511
		107	Top-mounting ring and bracket	19 903 1511
		112	Top-mounting ring and bracket	19 903 5511
	Floating valve opener for filters	112	Automatic drain valve	19 903 5560
		160	Automatic drain valve	19 903 2560
	Lubricating oil for CEJN Lubricators	107 / 112 / 160	Lubricating oil, 1 liter	19 903 1571
			Lubricating oil, 4 liters	19 903 1574
			Lubricating oil, 25 liters	19 903 1597
	Colour-coded filter elements	107	Sub-assembled filter element 25 µm	19 903 1540
			Sub-assembled filter element 5 µm	19 903 1541
			Sub-assembled filter element 0.01 µm	19 903 1542
		112	Sub-assembled filter element 25 µm	19 903 5540
			Sub-assembled filter element 5 µm	19 903 5541
	Bowl for filter with semi-automatic drain	107	Polycarbonate bowl	19 903 1900
		112	Polycarbonate bowl	19 903 5900
	Bowl for lubricator	107	Polycarbonate bowl	19 903 1901
		112	Polycarbonate bowl	19 903 5901
			Metal bowl	19 903 5903
			Polyamide bowl (for use in solvent-charged environments)	19 903 5904
	Moving parts for regulator	107	Moving parts for regulator	19 903 1902
		112	Moving parts for regulator	19 903 5902
	Polycarbonate cover, internal and external, visualization cover for lubricator	107 / 112	Polycarbonate cover	19 903 5906

CEJN reserves the right to make changes without further notification. Thread connections are listed according to ISO Standards. Other connections and sealing material on request. Check with an authorized CEJN distributor for availability and prices. Some part numbers may be subject to minimum order quantities. Please visit our website, www.cejn.com, for general maintenance tips.



Complementary Products

– Complementary Products for your Air Distribution System

Compact Pressure Tester

- *Easy to use*
- *Convenient way to spot-check pressure*
- *Lightweight*

The CEJN Compact Pressure Tester provides a safe and fast method to measure system outlet pressure and ensure air systems are working to specifications. The Pressure Tester also can be used to adjust the regulator during usage, as well as to locate and diagnose pressure differences.



	Description	Part No.
CEJN SERIES 300	Pressure Range, 0-10 bar (0-145 PSI)	19 900 9122
CEJN SERIES 310	Pressure Range, 0-10 bar (0-145 PSI)	19 900 9112
CEJN SERIES 315	Pressure Range 0-10 bar (0-145 PSI)	19 900 9132
CEJN SERIES 320	Pressure Range, 0-10 bar (0-145 PSI)	19 900 9102



CEJN reserves the right to make changes without further notification. Thread connections are listed according to ISO Standards. Other connections and sealing material on request. Check with an authorized CEJN distributor for availability and prices. Some part numbers may be subject to minimum order quantities. Please visit our website, www.cejn.com, for general maintenance tips.

Soft-Line Accessories

In the Soft-Line range, three accessories are included; accessory covers, assembly tool and kink protectors. The accessory covers are designed to be added onto couplings to "softens" the edges of quick connect couplings, making them non-abrasive and less likely to cause damage to surrounding components and surfaces. In addition, the covers also protect couplings from impact, prolonging the service life of the couplings.

The covers can be fitted on any regular series 300, 303, 310, 315 and 320 coupling. An assembly tool is delivered with the covers but can also be ordered separately. Kink-protectors can be used on all Stream-Line connections with the corresponding hose size. Kink protectors are sold separately and can be replaced during use with the cap nut on the Stream-Line connection.

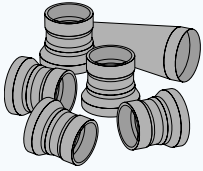
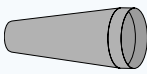

	Description	Connection	Part No.
ACCESSORY COVERS 	Accessory-style covers are available in packages of 10, including an assembly tool and assembly instructions. They are compatible with all standard Series 300, 303, 310, 315, 320, and 342 couplings.	-	19 900 7000
ASSEMBLY TOOL 	Assembly tool for accessory Soft-Line covers.	-	19 900 7050
FOR COUPLINGS AND NIPPLES 	Kink protectors can be used on all Stream-line couplings and nipples with the corresponding hose size. Kink protectors are sold separately and can be replaced during use with the cap nut on the Stream-Line connection.	6.5 x 10 mm 8 x 12 mm	10 300 4010 10 300 4012

Adapters – Connectors, Adapters, Bushings, & Plugs



A wide range of hose connectors; male-to-male adapters; bushings; plugs; cross, T-, L-, and Y-pieces; and ball valves for maximum flexibility in a variety of applications..

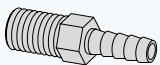
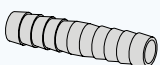

TECHNICAL DATA

Material Plated brass
 Max. working pressure..... 35 bar (507 PSI)

	Part No.	Connection 1	Connection 2
MALE TO HOSE - 	19 900 0211	R 1/8"	5 mm (3/16")
	19 900 0212	R 1/8"	6.3 mm (1/4")
	19 900 0221	R 1/4"	5 mm (3/16")
	19 900 0222	R 1/4"	6.3 mm (1/4")
	19 900 0223	R 1/4"	8 mm (5/16")
	19 900 0224	R 1/4"	10 mm (3/8")
	19 900 0225	R 1/4"	13 mm (1/2")
	19 900 0232	R 3/8"	6.3 mm (1/4")
	19 900 0233	R 3/8"	8 mm (5/16")
	19 900 0234	R 3/8"	10 mm (3/8")
	19 900 0235	R 3/8"	13 mm (1/2")
	19 900 0242	R 1/2"	6.3 mm (1/4")
	19 900 0243	R 1/2"	8 mm (5/16")
	19 900 0244	R 1/2"	10 mm (3/8")
	19 900 0245	R 1/2"	13 mm (1/2")
	19 900 0246	R 1/2"	16 mm (5/8")
	19 900 0247	R 1/2"	19 mm (3/4")
	19 900 0254	R 3/4"	10 mm (3/8")
	19 900 0255	R 3/4"	13 mm (1/2")
	19 900 0256	R 3/4"	16 mm (5/8")
19 900 0257	R 3/4"	19 mm (3/4")	
19 900 0258	R 3/4"	22 mm (1")	
HOSE TO HOSE - 	19 900 0262	6.3 mm (1/4")	6.3 mm (1/4")
	19 900 0264	10 mm (3/8")	10 mm (3/8")
	19 900 0265	13 mm (1/2")	13 mm (1/2")
	19 900 0267	R 1"	19 mm (3/4")
	19 900 0268	R 1"	22 mm (1")

	Part No.	Connection 1	Connection 2
MALE TO MALE - 	19 900 1210	G 1/8"	G 1/8"
	19 900 1211	G 1/4"	G 1/8"
	19 900 1212	G 1/4"	G 1/4"
	19 900 1213	G 1/4"	R 1/4"
	19 900 1214	G 1/4"	G 3/8"
	19 900 1215	G 1/4"	G 1/2"
	19 900 1217	G 1/4"	R 3/8"
	19 900 1220	G 1/8"	G 1/8"
	19 900 1221	G 3/8"	R 3/8"
	19 900 1222	G 3/8"	R 1/2"
	19 900 1224	G 3/8"	G 3/8"
	19 900 1225	G 3/8"	G 1/2"
	19 900 1229	G 1/2"	G 3/4"
	19 900 1227	G 3/8"	G 3/4"
	19 900 1235	G 1/2"	G 1/2"
	19 900 1236	R 1/2"	R 1/2"
	19 900 1237	G 1/2"	R 3/4"
	19 900 1246	G 3/4"	R 3/4"
	19 900 1247	G 3/4"	R 1"
	19 900 1248	G 3/4"	G 1"
	19 900 1249	G 3/4"	G 3/4"
	19 900 1268	G 1"	R 1"
	19 900 1269	G 1"	G 1"
	19 900 1312	NPT 1/4"	NPT 1/4"
	19 900 1314	NPT 1/4"	NPT 3/8"
	19 900 1324	NPT 3/8"	NPT 3/8"
	19 900 1325	NPT 3/8"	NPT 1/2"
	19 900 1335	NPT 1/2"	NPT 1/2"
	19 900 1337	NPT 1/2"	NPT 3/4"
	19 900 1348	NPT 3/4"	NPT 3/4"
	19 900 1349	NPT 3/4"	NPT 1"
	19 900 1369	NPT 1"	NPT 1"
	19 900 2237	G 1/2"	G 3/4"
	19 900 2235	G 1/2"	G 1/2"
19 900 2225	G 3/8"	G 1/2"	
19 900 2224	G 3/8"	G 3/8"	
19 900 2214	G 1/4"	G 3/8"	
19 900 2212	G 1/4"	G 1/4"	
19 900 2204	G 1/8"	G 3/8"	
19 900 2202	G 1/8"	G 1/4"	
19 900 2201	G 1/8"	G 1/8"	
MALE TO FEMALE - 			

CEJN reserves the right to make changes without further notification. Thread connections are listed according to ISO Standards. Other connections and sealing material on request. Check with an authorized CEJN distributor for availability and prices. Some part numbers may be subject to minimum order quantities. Please visit our website, www.cejn.com, for general maintenance tips.

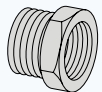
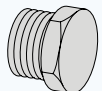
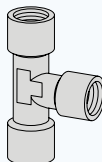
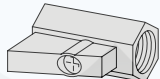
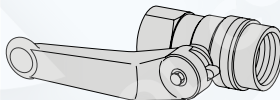
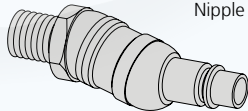
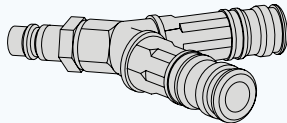
		Part No.	Connection 1	Connection 2		Part No.	Connection 1	Connection 2	
REDUCING MALE TO FEMALE	-	19 900 3211	G 1/4"	G 1/8"		L-PIECE	Male/Male	19 900 5361 G 1/8"	-
		19 900 3221	G 3/8"	G 1/8"			19 900 5362 G 1/4"	-	
		19 900 3222	G 3/8"	G 1/4"			19 900 5364 G 3/8"	-	
		19 900 3232	G 1/2"	G 1/4"			19 900 5365 G 1/2"	-	
		19 900 3234	G 1/2"	G 3/8"			Female/ 19 900 5371 G 1/8"	-	
		19 900 3244	G 3/4"	G 3/8"			Female/ 19 900 5372 G 1/4"	-	
		19 900 3245	G 3/4"	G 1/2"			19 900 5374 G 3/8"	-	
MALE PLUG	-	19 900 4302	G 1/4"	-		19 900 5375 G 1/2"	-		
		19 900 4304	G 3/8"	-		19 900 5379 G 1"	-		
		19 900 4305	G 1/2"	-		Male/ 19 900 5382 G 1/4"	-		
		19 900 4307	G 3/4"	-		Female/ 19 900 5384 G 3/8"	-		
T-PIECE	Female/	19 900 5304	G 3/8"	-		19 900 5385 G 1/2"	-		
	Female/	19 900 5305	G 1/2"	-		Female/ 19 900 5902 G 1/2"	-		
	Female	19 900 5309	G 1"	-		Female/ 19 900 5912 G 3/8"	-		
	Female/	19 900 5322	G 1/4"	-		Female/ 19 900 5916 G 1/4"	-		
	Male/	19 900 5324	G 3/8"	-		Female/ 19 900 5920 G 1/4"	-		
	Female	19 900 5325	G 1/2"	-		Male/ 19 900 5921 G 3/8"	-		
	Female/	19 900 5332	G 1/4"	-		Female/ 19 900 5925 G 1/2"	-		
	Female/	19 900 5334	G 3/8"	-		CROSS PIECE	Female/ 19 900 5904 G 3/8"	-	
	Male	19 900 5335	G 1/2"	-		Female/ 19 900 5903 G 1/2"	-		
				Female/ 19 900 5905 G 1/4"	-				
				Female/ 19 900 5906 G 1/8"	-				
				Male/ 19 900 5932 G 1/4"	-				
				Female/ 19 900 5934 G 3/8"	-				
				Female/ 19 900 5935 G 1/2"	-				
				Male					
				VALVE -MAX. W.P. 10 BAR	Female/ 19 900 9501 G 1/8"	-			
				Female	19 900 9502 G 1/4"	-			
									
				VALVE -MAX. W.P. 30 BAR	Female/ 19 900 9504 G 3/8"	-			
				Female	19 900 9505 G 1/2"	-			
					19 900 9507 G 3/4"	-			
									
				FREE ANGLE	Female/ 19 900 2622 Rc 1/4"	R 1/4"			
				Male/					
				Nipple	10 320 5183 R 1/4"	CEJN 320			
									
				Y-PIECE WITH COUPLINGS	-	10 310 5901 CEJN 310	CEJN 310		
						10 320 9200 CEJN 320	CEJN 320		
									

CEJN reserves the right to make changes without further notification. Thread connections are listed according to ISO Standards. Other connections and sealing material on request. Check with an authorized CEJN distributor for availability and prices. Some part numbers may be subject to minimum order quantities. Please visit our website, www.cejn.com, for general maintenance tips.



Adapters – Stream-Line Connections



CEJN Stream-Line connections are available with swivel and fixed adapters, both are offered with or without kink protectors.

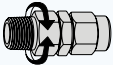

TECHNICAL DATA

Material Plated brass

	ID x OD	Part No.	Connection
SWIVEL ADAPTERS 	5 x 8 mm	19 958 0877	R 1/4"
		19 958 0892	NPT 1/4"
	6.5 x 10 mm	19 958 1077	R 1/4"
		19 958 1092	NPT 1/4"
	8 x 12 mm	19 958 1277	R 1/4"
		19 958 1292	NPT 1/4"
		19 958 1279	R 3/8"
		19 958 1294	NPT 3/8"
	9.5 x 13.5 mm	19 958 1377	R 1/4"
		19 958 1392	NPT 1/4"
		19 958 1379	R 3/8"
		19 958 1394	NPT 3/8"
11 x 16 mm	19 958 1687	R 1/2"	
	19 958 1695	NPT 1/2"	
SWIVEL ADAPTERS WITH KINK PROTECTORS 	5 x 8 mm	19 958 0876	R 1/4"
		19 958 0891	NPT 1/4"
	6.5 x 10 mm	19 958 1076	R 1/4"
		19 958 1091	NPT 1/4"
	8 x 12 mm	19 958 1276	R 1/4"
		19 958 1291	NPT 1/4"
		19 958 1278	R 3/8"
		19 958 1293	NPT 3/8"
	9.5 x 13.5 mm	19 958 1376	R 1/4"
		19 958 1391	NPT 1/4"
		19 958 1378	R 3/8"
		19 958 1393	NPT 3/8"
11 x 16 mm	19 958 1686	R 1/2"	
	19 958 1694	NPT 1/2"	
FIXED ADAPTERS 	5 x 8 mm	19 958 0812	R 1/4"
		19 958 0842	NPT 1/4"
	6.5 x 10 mm	19 958 1012	R 1/4"
		19 958 1042	NPT 1/4"
	8 x 12 mm	19 958 1212	R 1/4"
		19 958 1242	NPT 1/4"
		19 958 1214	R 3/8"
		19 958 1244	NPT 3/8"
	9.5 x 13.5 mm	19 958 1312	R 1/4"
		19 958 1342	NPT 1/4"
		19 958 1314	R 3/8"
		19 958 1344	NPT 3/8"
11 x 16 mm	19 958 1615	R 1/2"	
	19 958 1645	NPT 1/2"	
13 x 18 mm	19 958 1815	R 1/2"	

	ID x OD	Part No.	Connection
FIXED ADAPTERS WITH KINK PROTECTORS 	5 x 8 mm	19 958 0813	R 1/4"
		19 958 0843	NPT 1/4"
	6.5 x 10 mm	19 958 1013	R 1/4"
		19 958 1043	NPT 1/4"
	8 x 12 mm	19 958 1213	R 1/4"
		19 958 1215	R 3/8"
		19 958 1246	NPT 3/8"
		19 958 1243	NPT 1/4"
	9.5 x 13.5 mm	19 958 1313	R 1/4"
		19 958 1343	NPT 1/4"
	19 958 1315	R 3/8"	
	11 x 16 mm	19 958 1616	R 1/2"
9.5 x 13.5 mm	19 958 1345	NPT 3/8"	
11 x 16 mm	19 958 1646	NPT 1/2"	
KINK PROTECTORS 	6.5 x 10 mm	10 300 4010	6.5 x 10 mm
	8 x 12 mm	10 300 4012	8 x 12 mm

CEJN reserves the right to make changes without further notification. Thread connections are listed according to ISO Standards. Other connections and sealing material on request. Check with an authorized CEJN distributor for availability and prices. Some part numbers may be subject to minimum order quantities. Please visit our website, www.cejn.com, for general maintenance tips.

Adapters – Stainless Steel

A large range of hose connectors and male-to-male adapters in stainless steel.



TECHNICAL DATA

Material Stainless steel
Max. working pressure..... 35 bar (507 PSI)

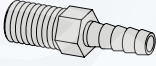
	Part No.	Connection 1	Connection 2		Part No.	Connection 1	Connection 2
MALE TO MALE 	19 900 1812	G 1/4"	G 1/4"	MALE TO HOSE 	19 900 0821	G 1/4"	1/4"
	19 900 1824	G 3/8"	G 3/8"		19 900 0831	G 3/8"	3/8"
	19 900 1835	G 1/2"	G 1/2"		19 900 0839	NPT 3/8"	3/8"
	19 900 1846	G 3/4"	G 3/4"		19 900 0849	NPT 1/2"	1/2"
	19 900 1869	G 1"	G 1"		19 900 0851	G 3/4"	3/4"
	19 900 1814	NPT 1/4"	NPT 1/4"		19 900 0859	NPT 3/4"	3/4"
	19 900 1834	NPT 3/8"	NPT 3/8"		19 900 0861	G 1"	1"
	19 900 1845	NPT 1/2"	NPT 1/2"		19 900 0869	NPT 1"	1"
	19 900 1848	NPT 3/4"	NPT 3/4"				
	19 900 1867	NPT 1"	NPT 1"				
	19 900 1813	G 1/4"	R 1/4"				
	19 900 1825	G 3/8"	R 3/8"				
	19 900 1836	G 1/2"	R 1/2"				
	19 900 1847	G 3/4"	R 3/4"				
19 900 1868	G 1"	R 1"					

CEJN reserves the right to make changes without further notification. Thread connections are listed according to ISO Standards. Other connections and sealing material on request. Check with an authorized CEJN distributor for availability and prices. Some part numbers may be subject to minimum order quantities. Please visit our website, www.cejn.com, for general maintenance tips.



Facts and Figures

General Information

- Use only high-quality, clean air. The best way to ensure this is to install an FRL unit.
- When compressed air leaves the system its turbulence creates noise that can be a stress factor in work environments. Noise can cause permanent hearing loss and can also be distracting and tiring at a lower sound level. If you are looking for blowguns with a noise level below 85 decibels, have a look at CEJN's OSHA compliant blowguns marked with an ear symbol!
- When using large vibration tools such as impact wrenches or rivet hammers, use a short hose (pigtail) between the tool and the coupling. This makes the couplings last longer since they are not as affected by the vibrations in the tool.
- Choose the proper connection for the application. Oversized connections cause unnecessary wear to the product while too small connections and hoses restrict the flow and reduce efficiency.
- When working with a vacuum, choose a coupling with O-ring sealing. Remember that the coupling and/or the nipple might need to be vacuum proof in disconnected position.
- CEJN uses silicone free manufacturing (LABS frei). No silicone is added in CEJN's production to avoid compressed air contamination that can spoil the result when working with varnish, wet paint or glue.
- To increase the lifespan of a 0.01 µm filter always use a 5 µm filter in front of it.
- When using an FRL unit in a solvent charged environment make sure to use a polyamide bowl.
- The user is responsible for damage caused by use other than intended. The limits of use for each product series are specified in the catalogue and at the homepage www.CEJN.com. If you have further questions please contact your local retailer or send us an e-mail.

Maintenance Tips

Before maintenance or repair work, make sure that the product is not pressurized and is disconnected from the air/media source. Before using or cleaning the products with solvent, please check that the chemical is compatible with the materials in the product. Please visit www.cejn.com or contact CEJN for a material list.

Couplings Nipples

- Avoid front-end impacts to the coupling and nipple. Damaged nipples also cause great wear on the coupling, shortening its lifespan. Impacts on the coupling's front-end may cause a malfunction.
- Check the nipples on a regular basis. If they are heavily worn or marked, replace them. Worn nipples lead to greater wear on the couplings.
- Keep the coupling and nipple clean and free of excess moisture.

Hoses and Hose Reels

- Check hoses and hose reel housing regularly for signs of damage. Any damage or defects must be repaired immediately. Repairs must be carried out by a qualified technician only. Original spare parts must be used!

FRL units

- Drain the bowl regularly, when full or buy a semi-automatic or fully automatic filter.



Technical Data

Air flow	Measured within an accuracy of $\pm 5\%$. The unit used is NI/min and stands for normal air litre per minute at $+20^{\circ}\text{C}$ ($+68^{\circ}\text{F}$) and 1.01325 bar (14.69595 PSI). Couplings are measured with a connection that does not restrict the flow. Series 0-299 is tested with $\frac{1}{4}$ " female thread, Series 300-399 with a $\frac{3}{8}$ " female thread, Series 400- is tested with $\frac{1}{2}$ " female thread.
Burst pressure	Measured in bar within an accuracy of $\pm 3\%$. Safety factor according to DNV No 2.9
CE Marking	CEJN Hose Reels are CE marked.
Connection force	Measured in Newton (N) at 6 bar inlet pressure.
Sound level	Measured at a distance of 1 metre in front of and 1 metre beside a 90° angle in front of the object. The unit used is dB (A) and stands for decibel on the A scale.
Temperature range	Measured in Celsius within an accuracy of $\pm 2^{\circ}\text{C}$.
Vacuum	Coupling series marked for vacuum use withstand minimum 70% absolute in connected position.

Sealing Materials

The standard coupling sealing material is NBR. CEJN can produce couplings with other sealing materials of your choosing on request. Please contact your nearest retailer for an offer.

MATERIALS	FEATURES	TEMPERATURE RANGE	MEDIA
NBR (Nitrile rubber Buna-N)	CEJNs standard seal for pneumatics. Resistant to water, gasoline, grease, mineral oil, heat, and alkalis. Sensitive to ozone.	-30°C to $+100^{\circ}\text{C}$ (-22°F to $+212^{\circ}\text{F}$)	Compressed air, oil, water
FPM (Fluorocarbon rubber Viton®)	Recommended for gasoline, oils, and acids. Weather-resistant. Not recommended for hot steam.	-15°C to $+200^{\circ}\text{C}$ (-5°F to $+392^{\circ}\text{F}$)	Chemicals, warm air
EPDM (Ethylene Propylene rubber)	Suitable for hot water, alkaline and acids. Not recommended for mineral oil.	-40°C to $+150^{\circ}\text{C}$ (-40°F to $+302^{\circ}\text{F}$)	Water

Contact CEJN for more detailed information regarding sealing material and chemical compatibility with CEJN couplings.



Beware of low quality products

CEJN products are recognized for their safety, high quality and long lasting durability. Low quality products cause leakage, over-production of compressed air and shorten the lifespan of system components. Make sure to look for the CEJN logo on products.

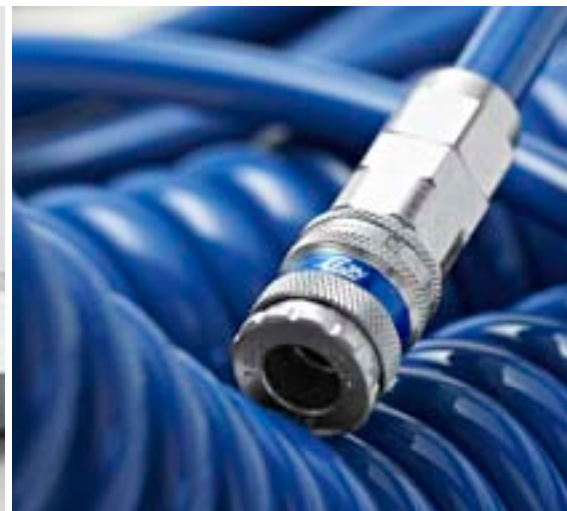

Connections and Thread Standards

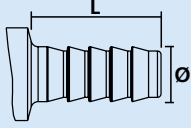
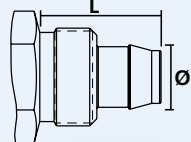
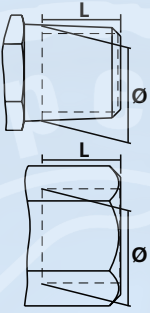
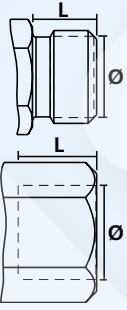
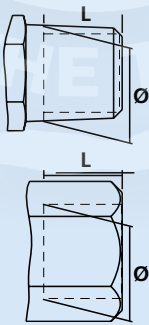
		Connection	Ø (mm)	L (mm)
Hose Connection Standard hose barb for hose clamp		6.3 mm (1/4")	7.6	18.0
		8 mm (5/16")	9.6	18.0
		10 mm (3/8")	11.2	21.0
		13 mm (1/2")	14.5	21.0
		16 mm (5/8")	17.8	23.0
Stream-Line Connection Hose barb with nut cap for reusable and safe hose clamping		5 x 8 mm	7.2	15.0
		6.5 x 10 mm	9.0	17.0
		8 x 12 mm	10.9	19.0
		9.5 x 13.5 mm	12.2	21.0
		11 x 16 mm	14.2	25.0
R/Rc Thread Connection Conical Pipe Thread Connection According to ISO 7/1 (Other common descriptions are BSPT, Kr) <i>Male: ie. R 1/4"</i> <i>Female: ie. Rp 1/4" (parallel)</i> <i>ie. Rc 1/4" (taper)</i>		Male Thread		
		R 1/8"	10.2	7.4
		R 1/4"	13.6	11.0
		R 3/8"	17.2	11.0
		R 1/2"	21.7	15.0
		R 3/4"	27.1	16.3
		Female Thread		
		Rc 1/8"	8.3	7.4
		Rc 1/4"	11.0	11.0
		Rc 3/8"	14.5	11.4
Rc 1/2"	18.0	15.0		
Rc 3/4"	23.5	16.3		
G Thread Connection Cylindrical Pipe Thread Connection According to ISO 228/1 (Other common descriptions are BSP, R) <i>Male: ie. G 1/4"</i> <i>Female (ISO 1179): ie. G 1/4"</i>		Male Thread		
		G 1/8"	9.6	8.0
		G 1/4"	13.0	10.0
		G 3/8"	16.5	10.0
		G 1/2"	20.8	12.0
		G 3/4"	26.3	12.0
		Female Thread		
		G 1/8"	8.75	7.4
		G 1/4"	11.8	11.0
		G 3/8"	15.25	11.4
G 1/2"	19.0	15.0		
G 3/4"	24.5	16.3		
NPT Thread Connection National Pipe Thread American standard according to ANSI/ASME B 1.20.1 <i>Male and female: ie. NPT 1/4"</i>		Male Thread		
		NPT 1/8"	10.5	6.7
		NPT 1/4"	14.0	10.2
		NPT 3/8"	17.5	10.4
		NPT 1/2"	21.8	13.6
		NPT 3/4"	27.1	13.9
		Female Thread		
		NPT 1/8"	8.5	6.9
		NPT 1/4"	11.0	10.0
		NPT 3/8"	14.5	10.3
NPT 1/2"	18.0	13.6		
NPT 3/4"	23.0	14.1		

Recommended Hose Dimension

Choose the correct hose kit for your application at:
www.cejn.com/hosekitguide





eSafe

The New Generation



CEJN Safety



New addition to the eSafe family

After the launch of eSafe, markets quickly realized the economic and environmental value. The new couplings instantly became a success. Now CEJN repeats the success with our two new series. We're happy to announce that during 2014 the eSafe range welcomes two new series: 430 and 550 (ISO 6150 B / A-A 59439).





CEJN *The Quick Connect*
Solution Provider

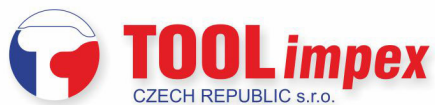

Hrabinská 498/19, 737 01 Český Těšín, Česka republika
Mobil: +420 731 018 782